

Mobile Board Instructions

03/18/15

Note: After assembly, peel the protective film from both sides of the board.

Cleaning Tip: A mild dish washing liquid can be used with a soft cloth to clean the writing surface.

Parts List

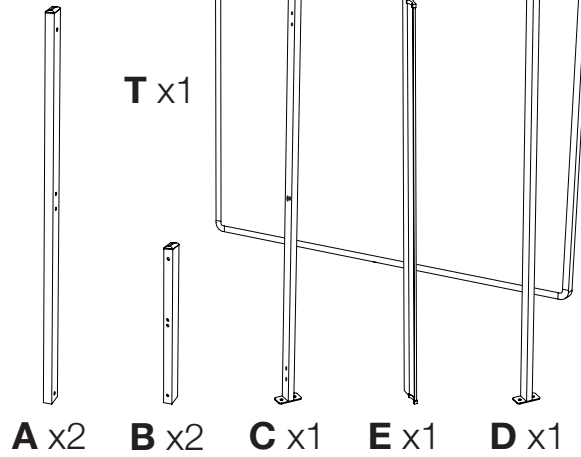

Tools Required

- Additional Wrench

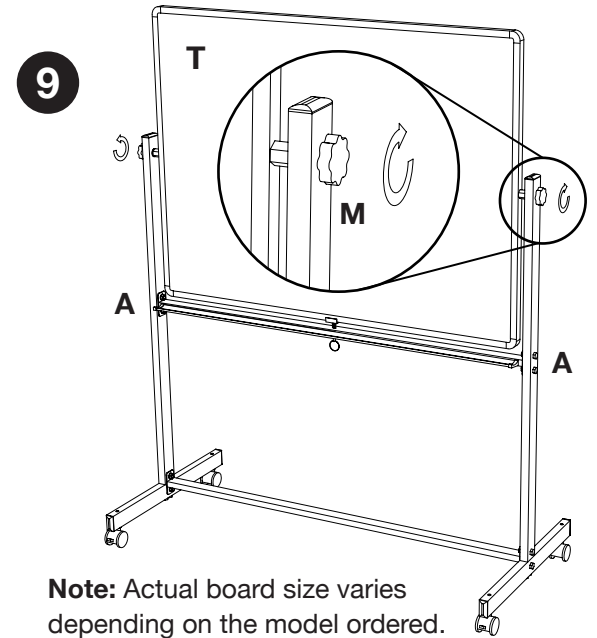
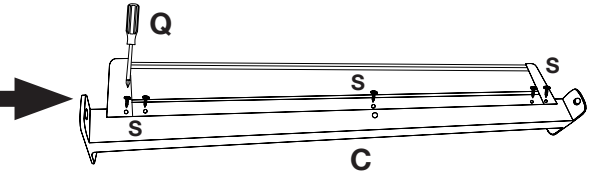
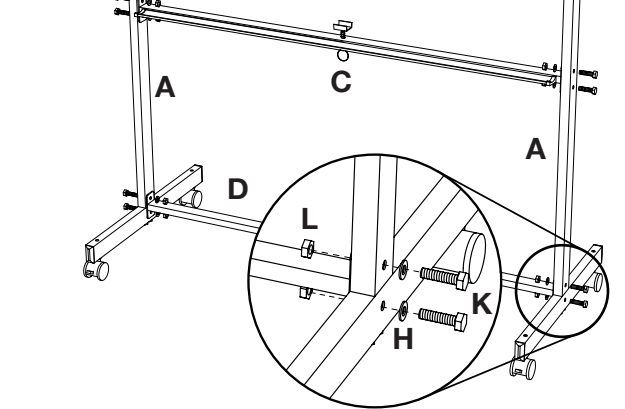
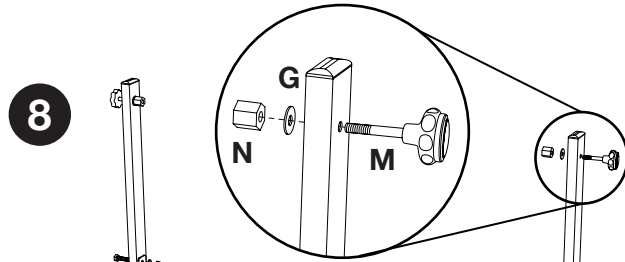
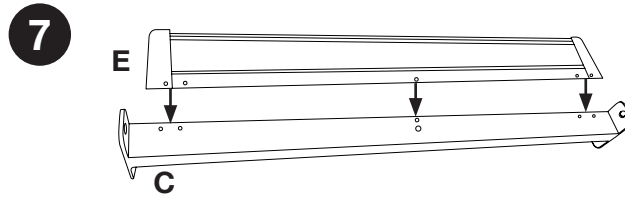
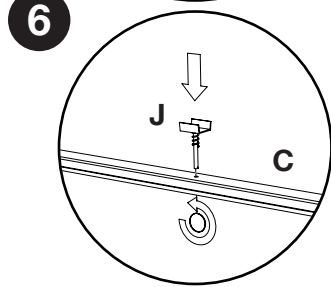
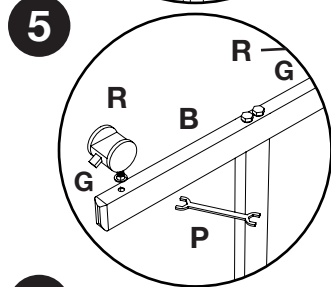
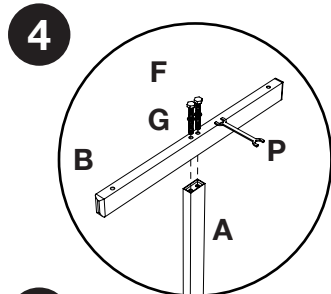
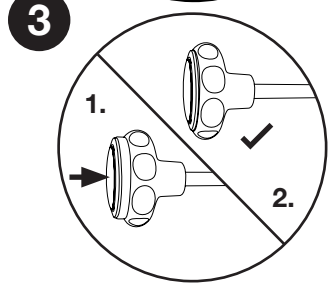
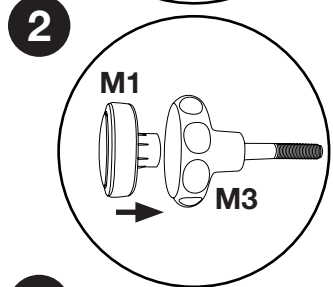
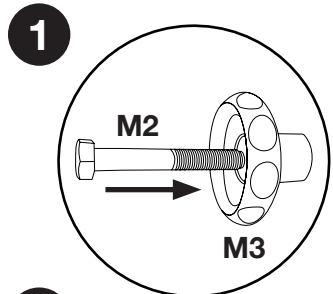
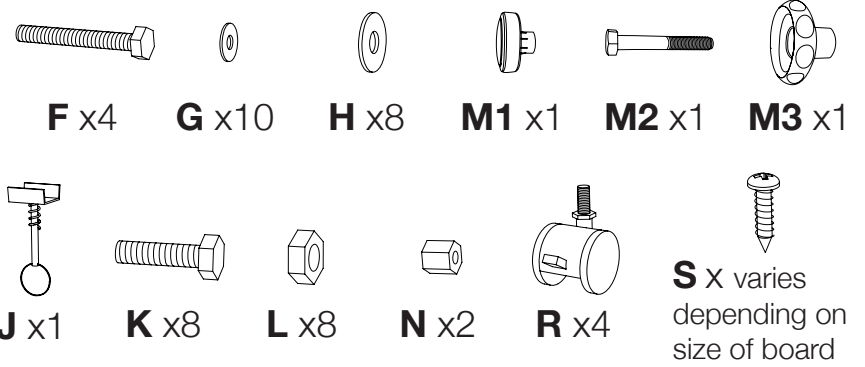
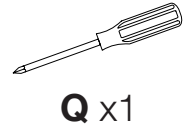
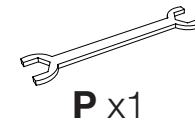

Note: Actual board size varies depending on the model ordered.