





USER MANUAL → ONE



USER MANUAL

→ ONE

→ INDEX

01 → Introduction	4
02 → Safety Information	6
2.1 General Safety Precautions	6
2.2 Load bearing capability of your iTrike	7
2.3 Location of important labels	8
2.4 Daily inspection and adjustments before driving	8
2.5 Safe handling and disposal of Li-Ion batteries	11
2.6 Charging Lithium Ion Batteries	15
03 → Controls and Components	16
3.1 Side View	16
3.2 Top View	16
3.3 Dashboard	17
3.4 Dashboard indicators	17
3.5 Handlebar controls	18
3.6 Foldable loading tray	20
3.7 Battery compartment	21
3.8 Folding the iTrike One	21



04 ➤ General Operation	22
4.1 Charging the battery	22
4.2 Starting procedure and riding	23
4.3 Braking	24
4.4 Parking and locking	25
4.5 Finding your iTrike on a parking	26
4.6 Storage of your iTrike	26
05 ➤ Maintenance and repair	27
5.1 Scheduled Maintenance and repair	27
5.2 Periodic maintenance and inspection items	28
5.3 Cleaning your itrike	29
06 ➤ Main Technical Data	30
07 ➤ Electrical Diagram	31
08 ➤ Troubleshooting	33
09 ➤ Periodic Maintenance Table	34
10 ➤ Owners informations	35
11 ➤ After sales / Maintenance	36

1. Preface

Congratulations and thank you for purchasing the iTrike One electric scooter. We welcome you to the ranks of iTrike owners and enjoy a safe and environmentally friendly driving.

Before driving, you must familiarize yourself with the contents of this manual; your safety depends on your familiarity with the operative technology and basic mechanical principles of your electric scooter.

As iTrike strives to continually improve the usability, handling and quality of our

electric vehicles, this manual contains the most current product information available at the time of printing. As a result, parts, pictures or content of this manual can slightly vary with your actual scooter. We reserve the right of final interpretation of this manual, and thank you for your understanding.

Before driving your iTrike, please check its basic functions and the current maintenance state of your vehicle, in case you might need maintenance or repair of your iTrike before driving, please check with your local ewheels dealer or service point.



Please keep this manual at hand for regular information. When the time comes to sell your iTrike, please hand it over together with the vehicle for reference of the new owner.

This manual is an essential part of the vehicle and should remain with it during its entire lifespan as stipulated by international law.

If after reading the manual, you still have questions concerning the operation or maintenance of your iTrike, please contact your reseller or contact our customer services on iTrike@msainternational.com, or contact us through our website www.itrike.eu

*We hope that you will **enjoy** your driving and wish you a safe and pleasant journey!*



Important notes

Please read this operator's manual carefully and make sure you understand the basic principles of operation before attempting to drive your iTrike on the road. **This vehicle is designed for only one driver to operate.** You can take a passenger with you on your iTrike, but please make sure not to exceed the load recommendations provided in this manual.

- ⚠ *Drive only on normal roads*
- ⚠ *You can drive in snow and rain*
- ⚠ *Avoid wading through water*

When water is flooding inside the central shaft, it can cause the failure of the electrical components, the battery or other parts of the scooter.

- ⚠ *Adapt your speed to traffic conditions*
- ⚠ *Adapt your braking distance*
- ⚠ *Anticipate brake maneuvers on wet and icy roads*

Please follow traffic rules and recommendations when driving your iTrike.

Warning decals on safety and environmental protection are placed on the rear cover of the steering compartment, the upper glove compartment and are clearly visible when operating the vehicle.

Never lend or borrow your scooter to inexperienced drivers or drivers who do not have the proper driving license.



By not abiding to the instructions and guidelines of this manual, operating the vehicle can result in mechanical damage, injuries or serious casualties.

Please make sure to carefully read and understand the principles of operation as stipulated in this manual





2.1 General Safety Precautions

Please read and understand the operator's manual and make sure that you are familiarized with the operation and components of your vehicle.

Before driving your iTrike, please perform a detailed security check of the operational components and check the battery status of your vehicle. **Never lend or borrow** your scooter to inexperienced drivers or drivers who do not have the proper driving license.

A lot of accidents happen due to lack of experience from the drivers. If you are uncertain of your level of driving experience or are new to electric scooters or motorcycles, please consider taking driving classes.

Speeding is a major factor in causing traffic accidents.

⚠ *Observe speed limitations when driving on public roads*

Please pay special attention when navigating road crossings, parking lots and carriageways. A lot of accidents happen in these places due to low visibility angles.

⚠ *Always establishing eye contact with other road users*

⚠ *Wearing bright colored clothes when driving in traffic*

⚠ *Avoid driving your iTrike at night or blinding sunlight*

When driving your iTrike, both hands must be placed on the handlebar and your feet must be firmly placed on the floorboards at all times.

⚠ *Never call or answer your phone while driving*

Using phones while driving is a major cause of inattention and is likely to cause traffic accidents. If you must answer your phone, pull over at a safe place and stop your vehicle first.

⚠ *Do not change lanes obtrusively*

Please make a turning signal in advance to change lanes. Observe the vehicles around you and start the maneuver when the road is clear.



Always wear a crash helmet and protective eyewear when riding your iTrike electric scooter

→ 2. SAFETY INFORMATION

2.2 Load bearing capability of your iTrike

Glove compartments, shelves and other storage facilities can only be loaded with lighter objects. The total weight of your load should not exceed the following values:

Glove compartment	10 kg
Total maximum load	150 kg



When calculating the scooter's total load bearing capability (max. 150 kg) and to estimate whether or not the vehicle is overloaded, you must take in account the weight of the driver, crew and all luggage.

Warning :

Your iTrike is not designed for use on irregular roads or off road use. Using the vehicle in these conditions can cause **faulty contacts** between electrical parts, and can lead to damaged suspension and frame.

We cannot be held responsible for **improper use** of your vehicle under these conditions. In case you encounter these conditions, please dismount the vehicle and walk next to it until you reach normal roads.





Only **use original components** for brake maintenance. Aftermarket brake pads or components can have a negative impact on the proper functioning of your braking system. Please contact your **local ewheels reseller** or service point for maintenance or repair.

Check the brake system :

Straighten the handle and check the brake fluid in the oil storage tank. The brake fluid must always be maintained between the upper and lower limit marks.

🔗 *Use only Dot3 or Dot4 oil for the brake system*

Check the brake pad wear when :

- ⚠ *the brakes reach the lower fluid limit*
- 🔊 *you hear noise under normal braking circumstances*
- 🔊 *the brake pads are worn or are noisy under braking*
- ⚠ *the lower oil limit has not been reached, check the brakes for leaks.*

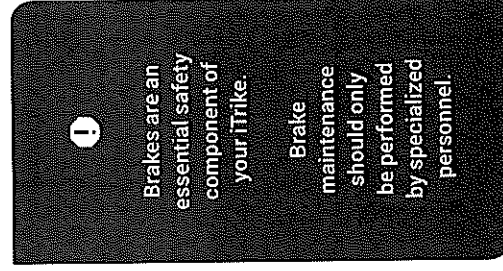

→ 2. SAFETY INFORMATION

Warning:

It is extremely **dangerous** to drive a vehicle with worn tires, which can impact the adhesive force between the road and the vehicle, and can have a negative influence on handling characteristics of the vehicle. Worn tires should be **replaced immediately** with new ones as soon as the central tread pattern reaches the following values:

Minimum tread pattern depth	Tire Pressure
Front Tire / 1.5 mm	2,5 Bar
Rear Tire / 2.0 mm	2,5 Bar

Check the tire pressure and tire wear routinely before driving your iTrike :

Check tires :

- ⊕ *pressure only after cooling the tires*
- ⊕ *for punctures. Repair them immediately when any air leaks are found*
- ⊕ *for shears, hairlines, or sharp objects in the tires surfaces*
- ⊕ *pattern for wear*

Tires have wear indicators in the rain grooves. Tires must be replaced as soon as the wear marks are reached.

- ⊕ *Check the rims for indentations or distortion*

Check the handlebar :

- ⊕ *for movement and flexible rotation*
- ⊕ *check if the handlebar axle is moving freely.*

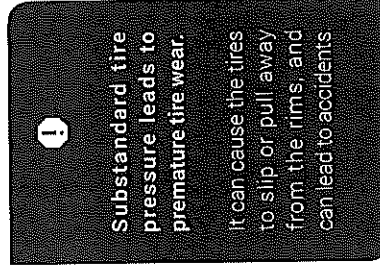



2.3 Location of important labels

The VIN number and Motor number are required for registration, licensing and verification for the annual maintenance, as well as for the repair and parts ordering during the 2 Year limited warranty period.

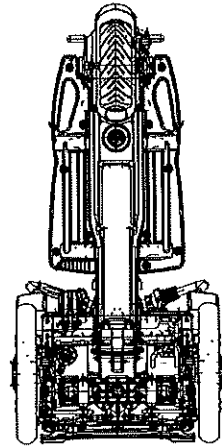

2.4 Daily inspection and adjustment before driving

Before driving, the driver must perform a **routine inspection** of the electrical system of the scooter to ensure that all functions are working properly.

- ⊕ Engage the left and right turning light and the head and tail lamps of the vehicle.
- ⊕ Non working lamps should immediately be replaced
- ⊕ Check the horn signal for sound
- ⊕ Check if the speed regulation of the turning handle is accurate, and if the handle automatically returns to its off position when released
- ⊕ Inspect the clearance of the brake handle
- ⊕ The free stroke of the brake handle should be between 10 and 20 mm

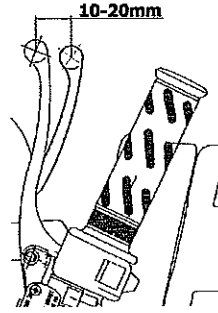



2.5 Safe handling and disposal of Lithium Ion Batteries

ITrike strives to offer the best possible quality and components currently available, therefore we have chosen to use only **Li-Ion batteries** in our vehicles. Below you will find more information on the advantages of Lithium-Ion Technology, and how Li-Ion batteries compare to other types of battery on the market.

2.5.1 Advantages of Lithium Ion batteries for use in electric vehicles

Li-Ion battery does not need prolonged priming when new. One regular charge is all that's needed. Self-discharge is less than half that of nickel-based batteries.

- ✔ *High energy density - potential for yet higher capacities*
- ✔ *More environmentally friendly than traditional batteries*
- ✔ *Low Maintenance - no periodic discharge is needed*

Specialty cells can provide very high current for applications in electric vehicles.

- ✔ *Shorter charging time than conventional batteries*
- ✔ *Lighter and smaller than other batteries (due to the higher energy density)*

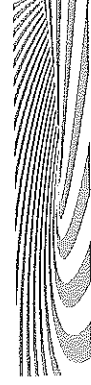



→ 2. SAFETY INFORMATION

2.5.2 Recommended use and maintenance of Li-Ion batteries

⚡ Partial discharge on Li-Ion is fine

After 30 charges, you should allow lithium-ion batteries to almost completely discharge. Store them at room temperature, ideally between 20 and 25 degrees C.

⚡ Avoid full discharges and charge the battery more often between uses

Never leave your battery where it is subjected to extremes in temperatures. This includes low levels as well as high

Do not leave batteries unused for extended periods of time, either in the vehicle or in storage

When a battery has been unused for 6 months, check the charge status and charge or dispose of the battery as appropriate. For extended storage, discharge a lithium-ion battery to about 40 percent and store it in a cool place.

Never store batteries in fully discharged state

Routinely check the battery's charge status

Carefully monitor batteries that are approaching the end of their estimated life

Consider replacing the battery if :

- The battery run time drops below about 80% of the original run time
- The battery charge time increases significantly



Batteries are not items that can be repaired by unauthorized users.

In case of faulty batteries, always contact your local authorized service point.

Disassembling batteries is dangerous and can result in electrical shocks, leaking batteries, fire hazard or explosion.





→ 2. SAFETY INFORMATION

2.5.3 Handling precautions

- ⊗ Do not disassemble, crush, or puncture a battery
- ⊗ Do not short circuit the external contacts on a battery
- ⊗ Do not dispose of a battery in fire or water
- ⊗ Do not expose a battery to temperatures above 60°C (140°F)
- ⊗ Keep the battery away from children
- ⊗ Avoid exposing the battery to excessive shock or vibration
- ⊗ Do not use a damaged battery
- ⊗ Do not touch any fluids if a battery pack has leaks
- ⊗ Immediately dispose of a leaking battery pack



Please prevent batteries from coming in contact with liquids; failure to do so may result in battery leaks, heating and smoking. In extreme cases, this can even lead to fire hazard or explosion.

If certain metals enter the battery compartment, this can lead to battery leaks, heating and smoking. In extreme cases, this can even lead to fire hazard or explosion

Prevent the battery from coming in contact with heat source, gasses and combustible fluids, to prevent fire hazard and explosion



IN CASE OF EYE CONTACT WITH FLUID, DO NOT RUB EYES.

Immediately flush eyes thoroughly with water for at least **15 minutes**, lifting upper and lower lids, until no evidence of the fluid remains. Seek medical attention.





2.5.4 Disposal of Lithium Ion Batteries

All waste batteries must be collected separately and sent for recycling. With lithium batteries, care must be taken to ensure that the batteries are not damaged while awaiting collection. On no account should these batteries be incinerated.

Special precautions and procedures are necessary for lithium polymer batteries. Undamaged batteries should be discharged and stored safely in salt water;

The detailed procedure is given below :

- ➊ Place the Lithium Polymer battery in a fireproof container or bucket of sand

Connect the battery to a Lithium Polymer discharger and discharge safely until its voltage reaches 1.0V per cell or lower

(maximum 16 V for the entire iStrike Battery).
Discharge the battery for up to 24 hours.

Prepare a bucket or tub containing 1-1,5 liters of cold water, and mix in 1/2 cup of salt per gallon of water. This container must be closed, but it does not need to be airtight.

- ➋ Drop the battery into the salt water.
Allow the battery to remain in the tub of salt water for at least two weeks.

- ➌ Remove the Lithium Polymer battery from the salt water and dispose of as hazardous waste.

- ➍ Damaged batteries should be placed directly into salt water and disposed of as hazardous waste.



Batteries containing metallic lithium become hazardous when the outer casing is damaged and the contents exposed or when subject to heat.

Lithium metal also heats up when exposed to water and can easily catch fire.

Lithium batteries can provide extremely high currents and can discharge very rapidly when short-circuited. A too-rapid discharge of a lithium battery can result in overheating of the battery, rupture, and even explosion.

Used Lithium batteries are considered a hazardous waste by the European Union, and must be disposed of according to the EU laws and directives. Disposing of Lithium Ion batteries as landfill or regular household waste is dangerous for humans and the environment, and can be punished by law.



2.6 Charging the batteries

- ⚠ Please charge batteries only under a temperature environment of 0-35° C

Avoid overcharging batteries, it reduces service life and can lead to overheating.

- ⚠ Do not charge batteries for more than 10 hours at a time
- ⚠ Batteries should only be charged with the matching special charger that is delivered with the vehicle

In order to ventilate and dissipate the heat associated with charging the batteries, it is prohibited to cover the charger or battery compartment when charging.

- ⚠ Do not cover the charger or battery compartment when charging
- Always store the charger in a dry and ventilated location, and do not put pressure or weight on the charger to avoid breakdown.
- ⚠ do not put pressure or weight on the charger
- ⚠ In areas of instable or fluctuating voltage supply, always use an AC voltage stabilizer

In case you need replacement or repair of the charger, please contact your local dealer or service point.

- ⚠ Never assemble the charger without prior approval

!

Use of non original chargers to charge the battery may cause the battery to leak, overheat or smoke, and can lead to fire hazards or explosion.

!

The battery will not charge at temperatures below 0°C. This function has been turned off on the battery management system for security reasons as well as to ensure long battery life.

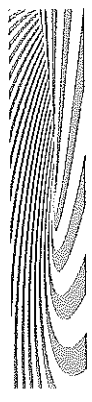



3.1 Side View

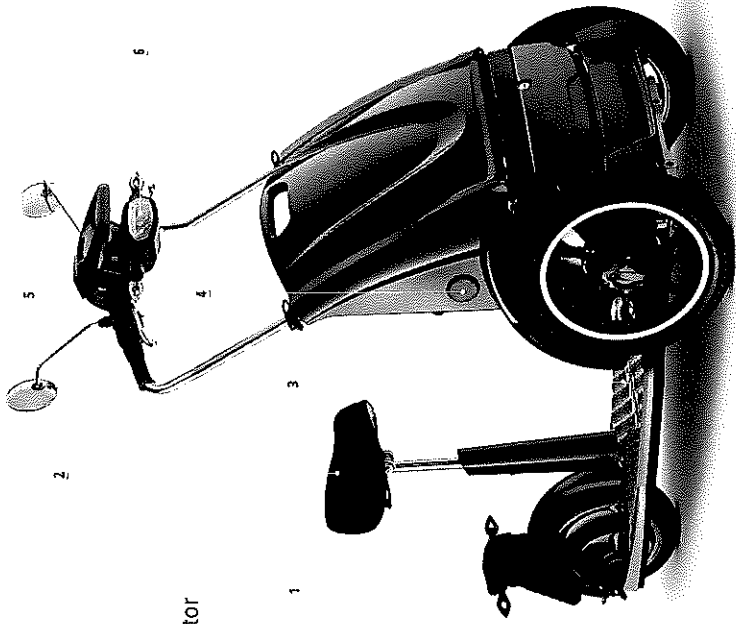

- 1 Rear light
- 2 Seat
- 3 Footboard
- 4 Side Reflector
- 5 Display
- 6 Head Light

3.2 Top view

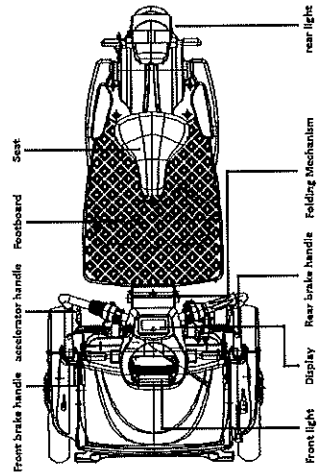

3.3 Dashboard

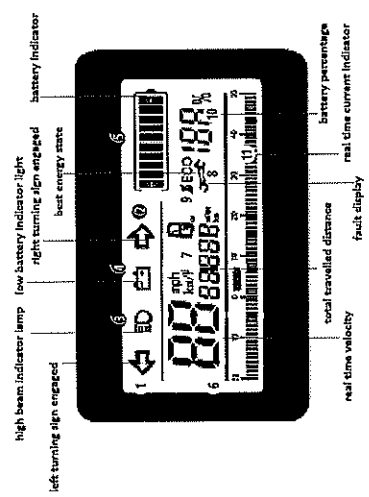

3.4 Dashboard Indications

- ① Left turning indicator light
- ② Right turning indicator light
- ③ High beam indicator light
- ④ Low battery indicator light
- ⑤ Battery indicator
- ⑥ Real time velocity
- ⑦ Total travelled distance
- ⑧ Fault display
- ⑨ Eco Mode/Best energy state
- ⑩ Battery percentage
- ⑪ Real time current indicator

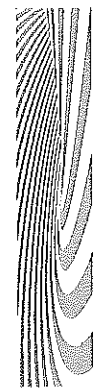

3.5 Handlebar Controls



Right handlebar

① Contact / power switch

- ① Hit the unlock key of remote control
- ② After unlock confirmation, insert the key and turn to '0' position. You can start and the keys cannot be pulled out
- ③ When the self-test of the electrical system is complete, the vehicle enters a waiting state
- ④ Hold the brake handle, lift the kick stand, let go of the brakes when driving.

② Gear Switch

Push down for reverse gear, up for forward gear.

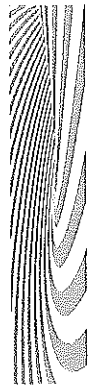
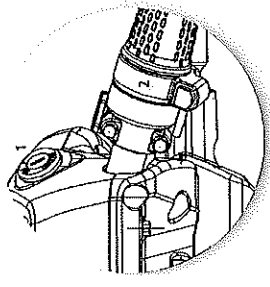



Left handlebar

1 **Headlight dimmer switch**

Press the headlight dimmer switch to regulate the distance light in upcoming traffic

2 **Turning indicator button**

Turn to the left position and the Left-turning light will light up. Turn to the right and the right-turning light will light up. Press the button toward the middle again to turn off the turning indicator lights.

3 **Horn switch**

Press down and the horn will beep immediately.



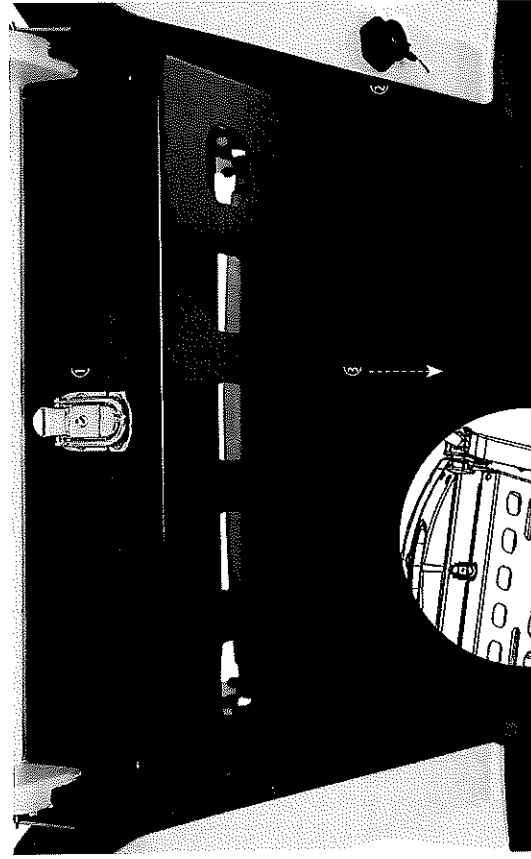

- ① Lock catch
- ② USB charging interface
- ③ Loading tray

3.6 Foldable loading tray

- ① The tray can either be used completely opened. If you want to transport smaller objects, first open the lock catch for placing your objects and make sure the lock catch is secured when driving.
- ② USB Charging Socket : Link the charging socket with the battery charger before connecting the charger to the power network. Then turn on the power of the charger to start charging the vehicle.

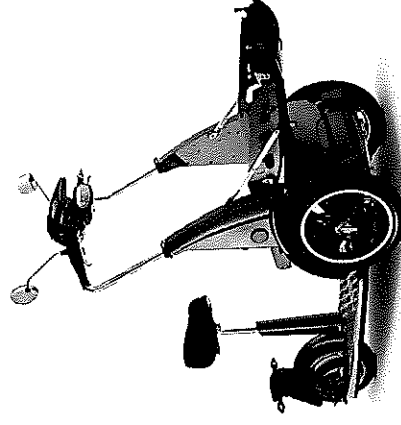

→ 3. CONTROLS AND COMPONENTS

3.7 Battery Compartment

- ① Insert the key into the keyhole on top to open the battery compartment. Lower the front door and insert or slide out the battery.

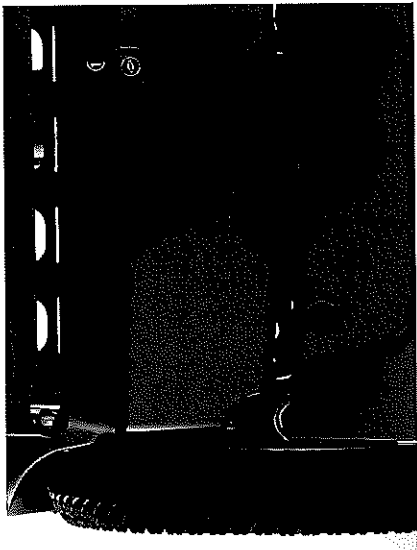

① Keyhole of battery compartment

3.8 Folding the iTrike One

- ② Remove the seat and seat base. Grab the pedal on the left side of the vehicle base, and lift the pedal slowly to fold the vehicle. To drive again, push down the pedal. Open the vehicle until you hear a positive 'click'. Reinstall the seat base and seat of the vehicle.

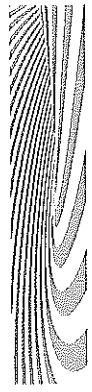
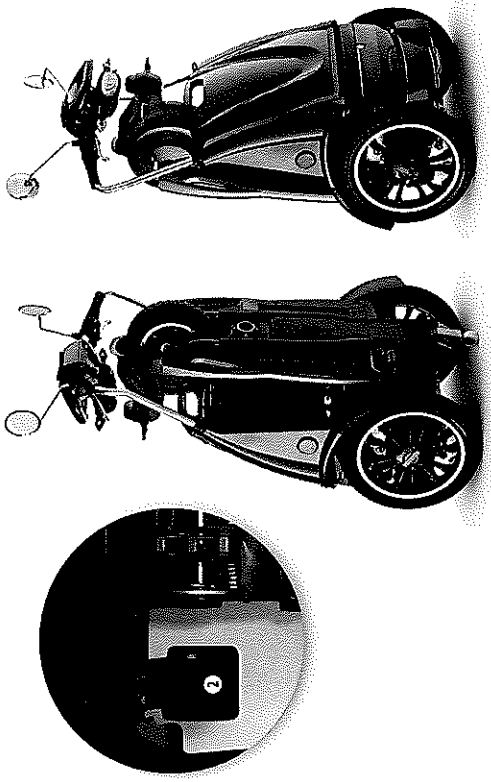



4.1 Charging the battery before operation

Your iTrike can be charged by connecting the battery charger to the charging port on the right of the frame under the silver trim.

- ⊕ *Connect the charging plug onto the battery charging socket until you hear a click to indicate that the battery is well connected*
- ⊕ *Connect the charger to an electric supply and turn on the charger*
- ⊕ *When the battery is charging, the indicator light turns from red to green.*
- ⊕ *The battery is fully charged when the indicator light returns to green.*

The instrument panel of your iTrike can indicate the actual electrical current of the battery while charging, by turning on the contact of the vehicle.

Alternatively you can choose to charge the battery directly from the charger. Remove it from the battery compartment to prevent theft of the vehicle, *(when you need to charge the battery in a public space or on a parking lot).*

To remove the battery for charging please follow the following steps :

- ⊕ *Connect the charging plug onto the battery charging socket until you hear a click to indicate that the battery is well connected*
- ⊕ *Connect the charger to an electric supply and turn on the charger*



If the battery is not fully charged after 10 hours of charging, please contact your local service center for repair or maintenance of your vehicle.

In order to preserve the batteries maximum service life, use it with a constant capacity between 20% and 80% of the total charging capacity. Lithium Ion batteries can fade in ordinarily at low temperatures. The available capacity is 70% at -10°C, 80% at 0°C and 100% at 25°C.

In order to prolong the battery life, it is best to complete a full charge and discharge cycle every 2 months. In case the vehicle is unused for prolonged periods of time, the battery should be stored with a minimum charge of 40% of the total capacity.

For more information about the maintenance and handling of lithium Ion batteries, please refer to chapter 2.5 of this manual.



Avoid speeding up rapidly on up-hills or on muddy or winding roads, to protect the motor and accumulator, and prevent rapid discharge of the battery.

4.2 Starting procedure and Riding

- ⊕ Always hold the handlebar with two hands while straddling the vehicle
- ⊕ Turn the ignition key on the front panel to the right to turn on the electrical system
- ⊕ Release the brakes

Rotate the handlebar in the right direction and gradually rotate the power handle on the right side of the handlebar to start driving.

Please turn the power handle evenly when you start driving. Avoid speeding up rapidly in order to ensure safe driving and to protect the motor and battery from overloading.

For maximum driving range :

- ⊕ Reduce braking times
- ⊕ Anticipate braking maneuvers
- ⊕ Drive fluently and controlled
- ⊕ Do not overload the vehicle



Do not turn on the contact or touch the power handle until you are properly seated on the trike and ready to start driving. When the contact is on, turning the power handle will cause the vehicle to suddenly rush forward. It can result in accidents or damage to the vehicle, and potentially dangerous injuries.

Always respect the traffic rules and adapt your driving to the local traffic conditions and weather. Plan ahead and use the controls and turning signals in a timely fashion to avoid losing control of the vehicle. Warn other road users of planned maneuvers.

Always wear a motorcycle helmet when driving, and avoid loose clothing. Long and loose shirts or sleeves can get caught up to braking handles or control systems and can lead to serious damage or injuries.





4.3 Braking

Your iTrike is equipped with front and rear disk brakes on the handlebar. The right hand lever operates the front brake and the left hand lever operates the rear brake.

For controlled braking, operate both levers at the same time, and apply the pressure gradually to avoid locking the brakes.

When braking on wet or curvy roads or in wintery conditions at medium high to high speeds always use **front and rear brake at the same time**:

When riding on humid or loose ground, or in rainy or icy conditions, the braking maneuvers must be anticipated and controlled in order to avoid slipping.

When the brakes are overheated, the braking efficiency is reduced, resulting in longer braking distances.

- ⓐ to avoid locking the brakes
- ⓑ to avoid slipping

Avoid overheating the brakes :

- ⓐ with rapid brake successions on hills or slopes
- ⓑ Use of the motor brake by controlling the power handle
- ⓒ Use the low gear of your iTrike

Always release the power handle to its original position before braking in order to cut the power to the engine. Keeping the engine under power when braking will result in premature wear of the brakes, and in rapid uncontrolled acceleration upon release of the brakes.





4.4 Parking and locking

When arriving at your parking place and standing still, rotate the ignition key counter clockwise to turn of the engine and electrical systems.

Warning :

- ⊕ Turn the ignition key completely to the left before removing it from the vehicle
- ⊕ After locking the vehicle, press the locking button on the key ring to fully lock the vehicle
- ⊕ Always park your vehicle on level ground
- ⊕ Lock all storage compartments before leaving your scooter
- ⊕ Always lock the vehical electrical system when you leave your iTrike unattended
- ⊕ When parking, always remove the ignition key from the vehicle
- ⊕ Use an additional anti-theft device when leaving the vehicle unattended
- ⊕ Do not leave any objects in sight when abandoning your iTrike in a public space



Physical blocking of the iTrike steering mechanism can only be performed with the ignition key in the contact in the neutral (middle) position.

When using the remote to lock the iTrike's electrical system please make sure to be within range of the vehicle. When the remote lock is activated, the turning signals will light up for several seconds to indicate a successful lock of the electrical system.

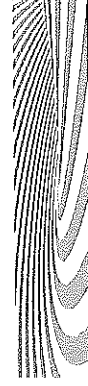



4.5. Finding your iTrike on a parking

To find your iTrike in a public parking, please press the motorcycle locating button on the remote control.

If your vehicle is within reach of the remote control, the turning signals will blink for 10 seconds, and an acoustic signal will be given.

In case of malfunctioning of the unlock system, the error can be relieved after 10 seconds, by first pressing the lock function on the remote control, then pressing the unlock button within reach of the iTrike.

After unlocking the electrical system, you can unlock the handlebar by turning the ignition key to its middle position, before following the normal starting procedure.

4.6. Storage of your iTrike

4.6.1 Short term Storage

- ⊕ Place your vehicle on level ground with good ventilation and ample space for maneuvering
- ⊕ Make sure the battery is charged for at least 50 % before storing the vehicle
- ⊕ Try to avoid storing the vehicle in direct sun or rain.
- ⊕ Fully charge the battery before reusing the vehicle
- ⊕ Turn of the power and remove the key prior to storing the vehicle, disconnect the battery plug from the vehicle

4.6.2 Long term storage

- ⊕ Place your vehicle on level ground with good ventilation and ample space for maneuvering
- ⊕ Make sure the battery is charged for at least 50 % before storing the vehicle
- ⊕ Try to avoid storing the vehicle in direct sun or rain.
- ⊕ Fully charge the battery before reusing the vehicle
- ⊕ Turn of the power and remove the key prior to storing the vehicle, disconnect the battery plug from the vehicle
- ⊕ Conduct a complete charge-discharge cycle of the battery every 2 months , and recharge them to at least 50%

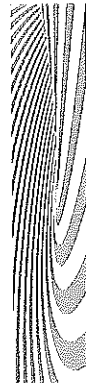



In order to expand the service life of your iTrike electric scooter and to enjoy a safe and comfortable ride, it is recommended to check and maintain the vehicle regularly, even when the vehicle has been unused for a prolonged period of time.

5.1 Scheduled maintenance and repair

it is required to perform the first maintenance after 500 km or one month of use, whichever comes first.

After the first maintenance, regular maintenance is required every 3000 km or every 6 months, in order to maintain your vehicle in the best possible state and to ensure the safety of both the vehicle and the driver(s).

The front fork, rear suspension and back shaft components should be greased regularly. The brake cables of the front and back brakes should be lubricated regularly to insure the proper functioning of the brakes.

In case of:

- ① continuous high load
- ② overloading the vehicle
- ③ continuous high speed driving
- ④ use on bumpy roads
- ⑤ or in uphill and downhill usage

The service interval must be shortened in order to guarantee the technical condition and safety of the driver and vehicle.

For more information on shortened service intervals, please contact your local service point, they are best placed to advise you on the correct service intervals for intensive use.



Please only use original parts for maintenance and repair.

Our original spare parts are subject to very strict quality control and guarantee the long-term quality and safety of your vehicle. iTrike cannot be held responsible for accidents or other damage or injuries in case non-original spare parts have been used for the maintenance and/or repair of your vehicle.



5.2 Periodic Maintenance and inspection items:

Regular safety and performance inspection	Regular mechanical maintenance	Electrical parts
Brake pads	Lubrication	Battery
Brake fluids	Wheel bearings	Main Harness
Horn	Shock absorber	Control System
Tires	Main frame	Electronic Parts
Lights and turning signals	Steering bearings	Wiring harness

For your own safety and the safety of others, the **technical maintenance** of your iTrike electric scooter should be performed by **qualified technicians** only.

Maintenance or repair of the iTrike should only be done on a leveled surface with the vehicle on the kickstand. In case it is necessary to check the repair during driving conditions, please pay special attention to the vehicles driving characteristics and the traffic around you.

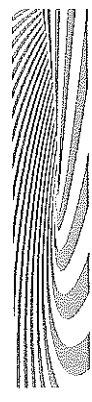

!

Do not attempt to disassemble the motor and controller without prior approval! In case you need to perform maintenance on the motor, battery or controller please contact your local service point.

5.3 Cleaning your iTrike

In order to ensure years of trouble-free use of your iTrike, the vehicle should be cleaned regularly, and the motor and other parts of your iTrike should be kept clean.

Please use only :

- ① water or soft neutral detergents to clean your iTrike
- ② soft cloth to dry your vehicle to avoid scratching the painted surfaces

Please ensure that :

- ③ the power is turned off
- ④ the ignition key has been removed from the vehicle before attempting any cleaning tasks on your iTrike

When cleaning :

- ⊕ avoid electric parts and drive parts
- ⊖ to come in direct contact with water
- ⊗ never use pressure washers on the axles, fork and electronic compartments of the vehicle

Never flush :

- ⊗ the sides and inner surface of the battery compartments directly with a water hose or pressure cleaner
- ⊗ the battery charger and controller with water



The charger operates under high voltage Alternating Current. Make sure that the scooter cannot fall over so that the controller comes in contact with water.

Do not connect the charger to the vehicle or the power socket when cleaning the vehicle. Do not charge the battery until the vehicle is completely dry. Electric shocks are very dangerous and can be lethal.





→ 6. MAIN TECHNICAL DATA

30

Main Dimensions	
Vehicle weight	61.4 kg
Maximum load capacity	150 kg
Wheelbase	937.9 mm
Ground clearance	67.4 mm
Front track	644 mm

Performance Data	
Maximum speed	25 km/h
Continuous voyage course	58 km

Motor and Battery	
Motor type	Brushless DC motor
Motor nominal power	800W
Motor nominal voltage	60V
Lithium battery specification	60V/20ah
Lithium battery type	18650 ternary lithium battery
Charge and discharge of battery	600 times

Electrical Components	
Controller	FOC sine wave controller
Speedometer	LCD
Charger input voltage	220V
Charger output voltage	65.8V
Charger output current	4A
Charging time	5-6h
Fuse cable specification	5A
Headlight specification	
Front position light specification	
Front turning light specification	12V LED
Rear turning light specification	
Rear light specification	
Plate light specification	

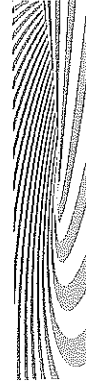

7. ELECTRICAL DIAGRAM

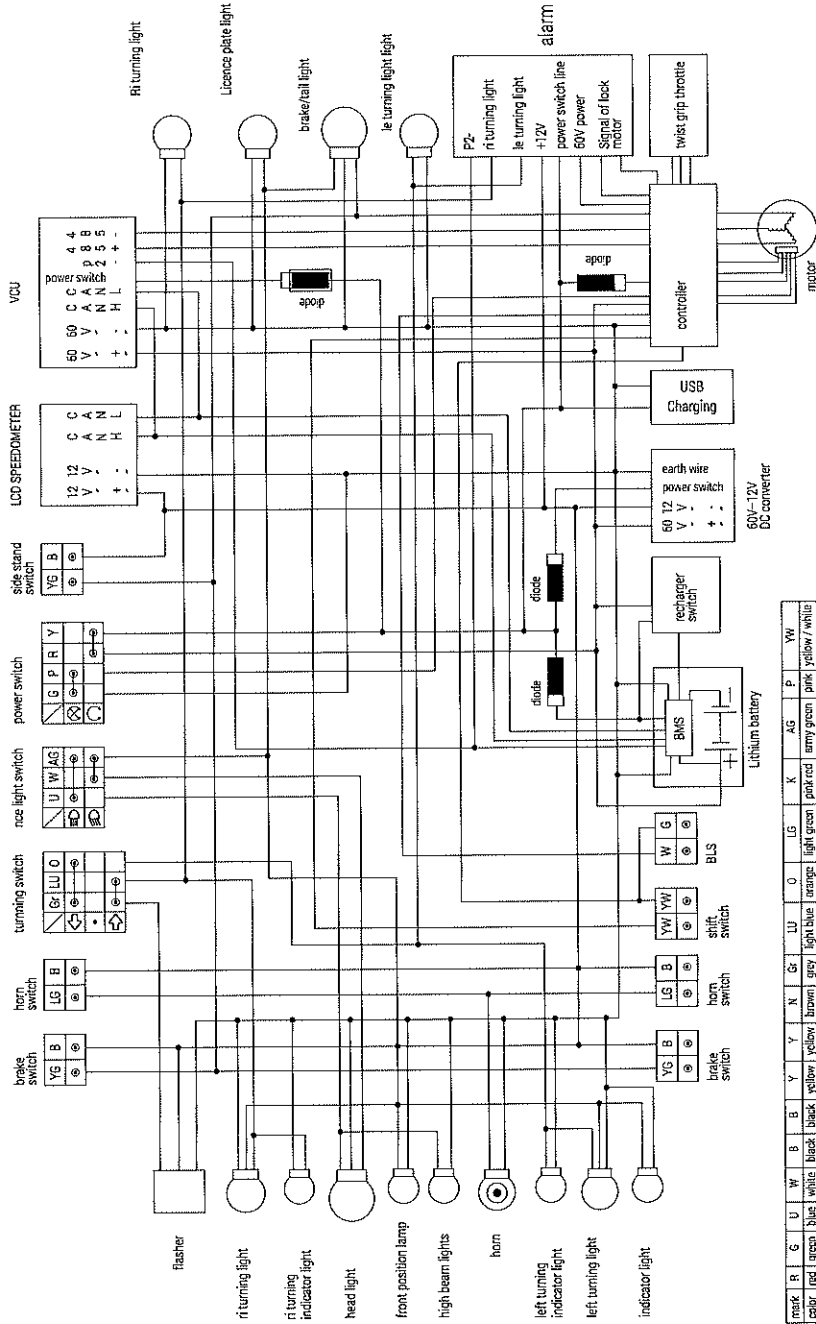



→ 8. TROUBLESHOOTING

FAULT DESCRIPTION	LIKELY CAUSE	SOLUTION
Contact on but No Power output	<ul style="list-style-type: none"> Battery plug is not inserted properly Contact switch faulty Battery empty Battery is faulty Blown fuse 	<ul style="list-style-type: none"> Remove key and reinsert battery plug Replace contact switch Charge battery Replace battery Replace fuse
Motor doesn't turn	<ul style="list-style-type: none"> Low battery Brake engaged Contact off Kickstand lowered Fault indicating lamp engaged 	<ul style="list-style-type: none"> Charge battery Disengage brake Turn contact key to on position Pull up kickstand Check fault information app on Smartphone or Contact service center
Speed is too low / range is too short	<ul style="list-style-type: none"> Low battery power Low tire pressure Aged or worn battery Low temperature 	<ul style="list-style-type: none"> Charge battery Check tire pressure and inflate tires Replace battery See technical data
Battery doesn't charge	<ul style="list-style-type: none"> Bad contact between charger and battery Charger broken 	<ul style="list-style-type: none"> Check the connection plug for looseness Replace charger



→ 9. PERIODIC MAINTENANCE TABLE 33

500 KM / First inspection	6000 KM / 12 Months	12000 KM / 24 Months	18000 KM / 36 Months	24000 KM / 48 Months
Vehicle Serial Number	Vehicle Serial Number	Vehicle Serial Number	Vehicle Serial Number	Vehicle Serial Number
Date of execution	Date of execution	Date of execution	Date of execution	Date of execution
Kilometers	Kilometers	Kilometers	Kilometers	Kilometers
Parts Used	Parts Used	Parts Used	Parts Used	Parts Used
Dealer stamp	Dealer stamp	Dealer stamp	Dealer stamp	Dealer stamp



→ 9. PERIODIC MAINTENANCE TABLE

30000 KM/ 60 Months	36000 KM/ 72 Months	42000 KM/ 84 Months	48000 KM/ 96 Months
Vehicle Serial Number	Vehicle Serial Number	Vehicle Serial Number	Vehicle Serial Number
Date of execution	Date of execution	Date of execution	Date of execution
Kilometers	Kilometers	Kilometers	Kilometers
Parts Used	Parts Used	Parts Used	Parts Used
Dealer Stamp	Dealer Stamp	Dealer Stamp	Dealer Stamp



→ 10. OWNERS INFORMATIONS

1 st Owner	2 nd Owner	3 rd Owner
Name :	Name :	Name :
Address :	Address :	Address :
Tel :	Tel :	Tel :
Email :	Email :	Email :
Insurance Number :	Insurance Number :	Insurance Number :
Purchase date :	Purchase date :	Purchase date :
Sold On :	Sold On :	Sold On :

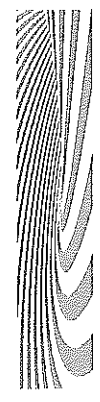



11. Contact information

11.1. ewheels

JHR ELECTRIC TRANSPORTS LLC
850 E COVEY LANE
85024 PHOENIX
UNITED STATES

11.1.2. Dealer Information

(Place dealer stamp here)







USER MANUAL → ONE

