



# UROLOGICALS

CHOICE. EXPERTISE. QUALITY.

COMPREHENSIVE SELECTION • INNOVATIVE PRODUCTS • EVIDENCE-BASED PROGRAMS



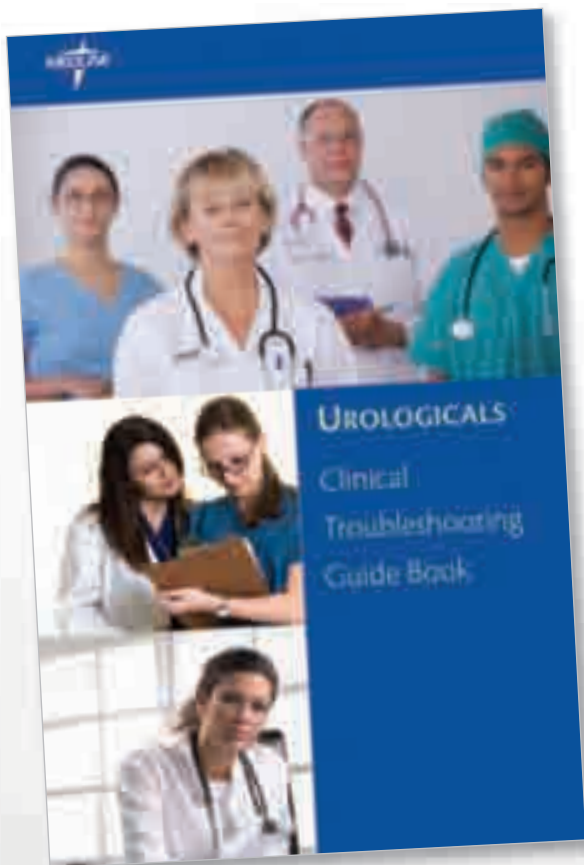

## Urologicals Clinical Troubleshooting Guide Book

This authoritative guide is designed to help facilities achieve excellence in urological care. It keeps vital information close at hand, helping caregivers reduce difficulties, complications and infections associated with urinary catheters.

**To receive your copy, contact your sales representative or call 1-800-MEDLINE.**

### VISIT US AT MEDLINE.COM:

- 1 Download a QR Code reader app
- 2 Launch app
- 3 Hover the phone over this QR Code



#### References:

1. Surgical Care Improvement Project. SCIP-Inf-10: Surgery Patients with Perioperative Temperature Management. Specifications Manual for National Hospital Inpatient Quality Measures.
2. Guideline for Prevention of Catheter-associated Urinary Tract Infections, 2009. Centers for Disease Control and Prevention, Healthcare Infection Control Practices Advisory Committee (HICPAC). Available at: [http://www.cdc.gov/hicpac/cauti/02\\_cauti2009\\_abbrev.html](http://www.cdc.gov/hicpac/cauti/02_cauti2009_abbrev.html). Accessed June 6, 2011.
3. Lo E, Nicolle L, Classen D, et al. Strategies to Prevent Catheter-Associated Urinary Tract Infections in Acute Care Hospitals. *Infection Control and Hospital Epidemiology*. 2008;29:S41-S50. Available at: <http://www.premierinc.com/safety/topics/HAI/downloads/HAI-Compendium-HAI-ca-uti.pdf>. Accessed February 7, 2011.
4. Guideline for Prevention of Catheter-associated Urinary Tract Infections, 2009. Healthcare Infection Control Practices Advisory Committee (HICPAC), Centers for Disease Control and Prevention. Available at: [http://www.cdc.gov/hicpac/cauti/002\\_cauti\\_sumORcom.html](http://www.cdc.gov/hicpac/cauti/002_cauti_sumORcom.html). Accessed June 21, 2011.
5. Child Life: Empowering Children and Families to Cope With Life's Challenges. Child Life Council, Inc. 2010. Fact sheet accessed at: <http://www.childlife.org/the%20child%20life%20profession/>



**Medline Industries, Inc.**  
One Medline Place  
Mundelein, IL 60060

**Medline United States**  
**1-800-MEDLINE (633-5463)**  
[www.medline.com](http://www.medline.com)  
[info@medline.com](mailto:info@medline.com)

**Medline Canada**  
**1-800-396-6996**  
[www.medline.ca](http://www.medline.ca)  
[canada@medline.com](mailto:canada@medline.com)

**Medline México**  
**01-800-831-0898**  
[www.medlinemexico.com](http://www.medlinemexico.com)  
[mexico@medline.com](mailto:mexico@medline.com)

Some products may not be available for sale in Mexico or Canada. We reserve the right to correct any errors that may occur within this brochure. ©2011 Medline Industries, Inc. Medline, Aloetouch, Exo-Cath, Foley Insetag and Silvertouch are registered trademarks of Medline Industries, Inc. Tyvek and Mylar are registered trademarks of du Pont de Nemours and Company. BioCon is a registered trademark of Mcube Technology Co., Ltd. UltraFlex is a registered trademark of Rochester Medical.



## IMPROVING CARE BY DESIGN

For over 30 years, Medline has been supplying high-quality urological products to healthcare facilities like yours. Our innovative products and programs help clinicians to intuitively follow best practices and provide exceptional patient care.

The ERASE CAUTI® program (pgs. 4, 32-37) includes accredited continuing education and a revolutionary tray that minimizes the risk of urinary catheter-associated infections. Our Temperature-Sensing Foley Catheters (pgs. 15-17) help you comply with SCIP-Inf-10 guidelines.

Through consistent high quality and a wide selection, Medline has become a leading urological supplier.

## TABLE OF CONTENTS

Clinical Resources . . . . .	4
Foley Catheters . . . . .	6
Drain Bags . . . . .	18
Catheter Securement Devices . . . . .	26
Closed-System Trays . . . . .	30
Alternatives to Foley Catheters . . . . .	44
Pediatrics . . . . .	52
Additional Products . . . . .	60
Index . . . . .	72



## CLINICAL RESOURCES

At Medline, we're committed to providing you with resources for authoritative clinical information. Our comprehensive programs and accredited continuing education can help you comply with the latest industry standards for providing exceptional care.

**ERASE  
CAUTI**

**A new innovative tray design  
to help change clinical behavior**



**Medline's revolutionary patented ERASE CAUTI® Tray** features a re-engineered Foley catheter tray that helps to improve the insertion process by incorporating evidence-based solutions which minimizes the risk of urinary catheter-associated infections. See page 32 for additional information.



[www.erasecauti.com](http://www.erasecauti.com)

## Comprehensive Programs

Our ERASE CAUTI® program includes accredited continuing education that features a simulation of a standardized Foley catheterization procedure. The ERASE CAUTI education, combined with our revolutionary ERASE CAUTI Tray, can help you minimize the risk of urinary catheter-associated infections in your facility.

In addition to ERASE CAUTI, Medline offers a variety of comprehensive programs, including Hand Hygiene, Pressure Ulcer Prevention and more. Designed in conjunction with input from facilities like yours, these programs are very effective for increasing staff expertise and ensuring adherence to best practices.

## Accredited Continuing Education

Medline is proud to offer Medline University® (MU), our FREE online clinical education resource. MU courses promote evidence-based practices, based on the guidelines of the CDC, Joint Commission, SHEA and APIC. Through MU, you can access our online ERASE CAUTI education, an important part of our ERASE CAUTI program.

*For more information about Medline University, our patented catheter tray, ERASE CAUTI Program or any of our other innovative programs, contact your Medline representative, or visit [www.medline.com](http://www.medline.com)*



[www.medlineuniversity.com](http://www.medlineuniversity.com)





## CATHETERS

In Medline's selection of Foley catheters, you'll find the sizes and materials to meet the needs of all your catheterized patients. Advanced Temperature Sensing Foley catheters offer exceptional safety by monitoring the patient's core body temperature via the bladder. Our exclusive Silvertouch<sup>®</sup> Foley catheters have an inner and outer coating of ionic silver for effective antimicrobial protection.





## IN THIS SECTION

100% Silicone Foley Catheters – Latex Free . . . . .	8
Silvertouch® Foley Catheters – Latex Free . . . . .	10
Silicone-Elastomer Coated Latex Foley Catheters . . . . .	12
Lubricious Hydrophilic Latex Foley Catheters . . . . .	14
Temperature-Sensing Foley Catheters – Latex Free . . . . .	15



## 100% Silicone Foley Catheters

Maximize safety and comfort with our 100% Silicone Foley catheters.

- Completely inert – less tissue irritation and encrustation during extended periods of indwelling use
- Bullet-shaped tip – easier insertion and less buckling
- Large, smooth eyes – maximum comfort
- Large inner drainage lumen – 30% larger than those on latex catheters (0.1297 mm vs. 0.094 mm on traditional 16 Fr catheter)
- Clear – easy visualization of clots, mucous and urine flow
- Radiopaque strip – ease of visualization during scans
- Symmetrical balloon shape – improved reliability



*Symmetrical balloon shape helps with maintaining proper retention.*

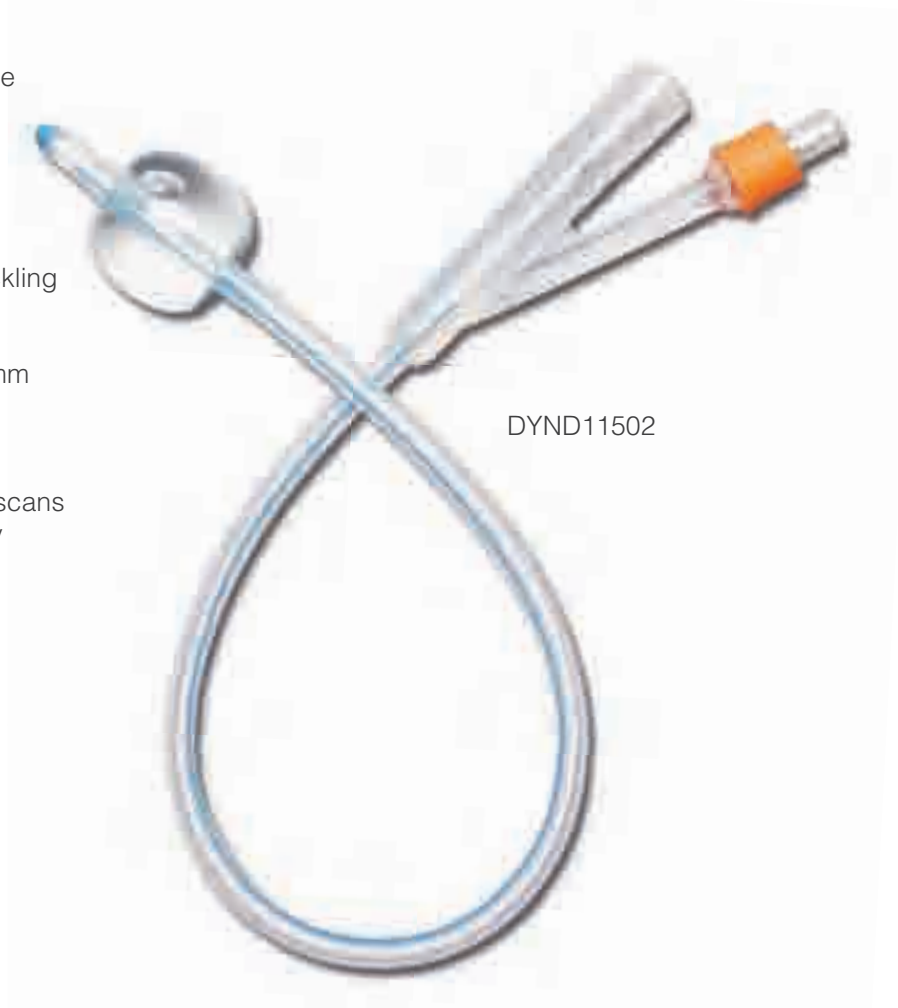

### 2-WAY 100% SILICONE FOLEY CATHETERS – LATEX FREE

ITEM NUMBER	SIZE	BALLOON SIZE	PKG	HCPCS
DYND11552	6 Fr	1.5 ml	10/cs	A4344
DYND11553	8 Fr	3 ml	10/cs	A4344
DYND11554	10 Fr	3 ml	10/cs	A4344
DYND11500	12 Fr	10 ml	10/cs	A4344
DYND11501	14 Fr	10 ml	10/cs	A4344
DYND11502	16 Fr	10 ml	10/cs	A4344
DYND11503	18 Fr	10 ml	10/cs	A4344
DYND11504	20 Fr	10 ml	10/cs	A4344
DYND11505	22 Fr	10 ml	10/cs	A4344
DYND11506	24 Fr	10 ml	10/cs	A4344
DYND11532	16 Fr	30 ml	10/cs	A4344
DYND11533	18 Fr	30 ml	10/cs	A4344
DYND11534	20 Fr	30 ml	10/cs	A4344
DYND11535	22 Fr	30 ml	10/cs	A4344
DYND11536	24 Fr	30 ml	10/cs	A4344

## Specialty Tiemann/Coude-Tip 100% Silicone Foley Catheters

For difficult insertions, coude-tip Foley catheters feature a bent tip that maneuvers around obstructions leading to the bladder.

- Large oval-shaped eye – maximum drainage
- Smooth reinforced tip – resists buckling
- Completely inert - less tissue irritation and encrustation during extended periods of indwelling use



DYND11592

### 2-WAY TIEMANN/COUDE TIP 100% SILICONE FOLEY CATHETERS – LATEX FREE

ITEM NO.	SIZE	BALLOON SIZE	PKG
DYND11591	14 Fr	10 ml	10/cs
DYND11592	16 Fr	10 ml	10/cs
DYND11593	18 Fr	10 ml	10/cs
DYND11594	20 Fr	10 ml	10/cs

## 3-Way 100% Silicone Foley Catheters

The 3-way Foley catheter adds continuous irrigation capabilities after bladder or other urinary surgeries.

- Medications or other solutions can be continuously introduced into the bladder
- Large inner drainage lumen – 30% larger than those on latex catheters
- Radiopaque tip for ease of visualization during scans
- If irrigation is discontinued, a catheter plug may be used to close the lumen (see DYND12200 on page 25)



DYND11576

### 3-WAY 100% SILICONE FOLEY CATHETERS – LATEX FREE

ITEM NO.	SIZE	BALLOON SIZE	PKG
DYND11572	16 Fr	30 ml	10/cs
DYND11573	18 Fr	30 ml	10/cs
DYND11574	20 Fr	30 ml	10/cs
DYND11575	22 Fr	30 ml	10/cs
DYND11576	24 Fr	30 ml	10/cs

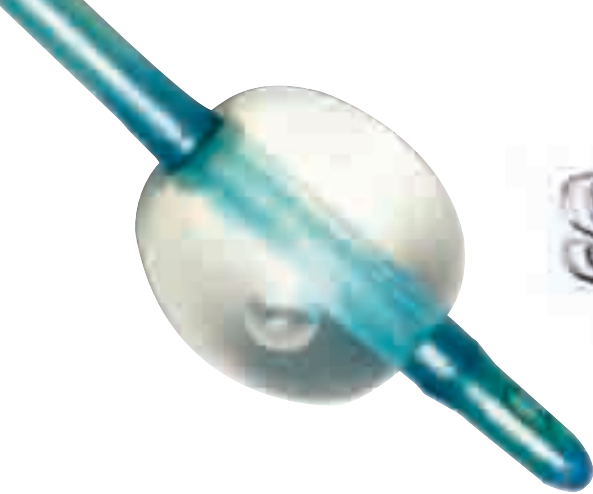

# SILVERTouch

## Foley catheter

### Silver ions provide antimicrobial action

Silver ions have long been recognized for their broad-spectrum antimicrobial action. Ionic silver is effective against gram-positive and gram-negative bacteria, as well as fungi. Ionic silver hydrophilic catheter coatings can be very effective against the most common and serious UTI pathogens, including MRSA, VRE, E. coli, Candida albicans, Staph aureus, Pseudomonas, Klebsiella, and others (see chart below). Silvertouch catheters incorporate the power of silver through a patented UV bonding process that binds silver ions to the catheter's lubricious coating.



*The Zone of Inhibition (ZOI) diameter is a measure of the effectiveness of a compound. The larger the clear area, the more effective the compound.*

	<b>E.COLI</b>	<b>P. AERUGIN</b>	<b>K. PNEUM</b>	<b>C. ALBICAN</b>	<b>MRSA</b>
Silvertouch avg ZOI (mm)	5.13	5.80	4.93	4.93	25.13
	<b>E.CLOACAE</b>	<b>C. KOSERI</b>	<b>VRE</b>	<b>E. FAECALIS</b>	<b>S. SAPRO</b>
Silvertouch avg ZOI (mm)	5.07	5.00	2.00	2.00	7.73

## Silvertouch® Foley Catheters

A patented process permanently binds silver ions to the catheter's inner and outer surface. The catheter is completely inert and made of 100% silicone, so it poses no risk of allergic reaction to latex.

- Pure ionic silver – powerful antimicrobial protection against gram-positive and gram negative bacteria, as well as fungi
- Bonded lubricious hydrophilic coating – hydrates rapidly and improves patient comfort over time
- 100% Silicone – offering patients and caregivers the safety of a latex-free product

*“The best way to reduce the morbidity, mortality, and associated costs of catheter-associated UTI is to prevent or minimize bacteriuria.”*

*(Ref: Alcaid & Lichtstein, Hospital Physician, August 2004)*



DYND141016

### 2-WAY SILVERTOUCH FOLEY CATHETERS – LATEX FREE

ITEM NUMBER	SIZE	BALLOON SIZE	PKG	HCPCS
DYND141010	10 Fr	3 ml	10/cs	
DYND141012	12 Fr	10 ml	10/cs	
DYND141014	14 Fr	10 ml	10/cs	A4344
DYND141016	16 Fr	10 ml	10/cs	A4344
DYND141018	18 Fr	10 ml	10/cs	A4344
DYND141020	20 Fr	10 ml	10/cs	A4344
DYND141022	22 Fr	10 ml	10/cs	
DYND141024	24 Fr	10 ml	10/cs	
DYND141216	16 Fr	30 ml	10/cs	A4344
DYND141218	18 Fr	30 ml	10/cs	A4344
DYND141220	20 Fr	30 ml	10/cs	A4344

## Silicone-Elastomer Coated Latex Foley Catheters

Our innovative manufacturing process ensures the maximum amount of silicone coating available.

- Silicone-elastomer coating – helps prevent encrustation
- Large smooth drainage eyes – maximum comfort
- Latex – soft, flexible and conformable



*Symmetrical balloon for added reliability and proper placement in the bladder.*

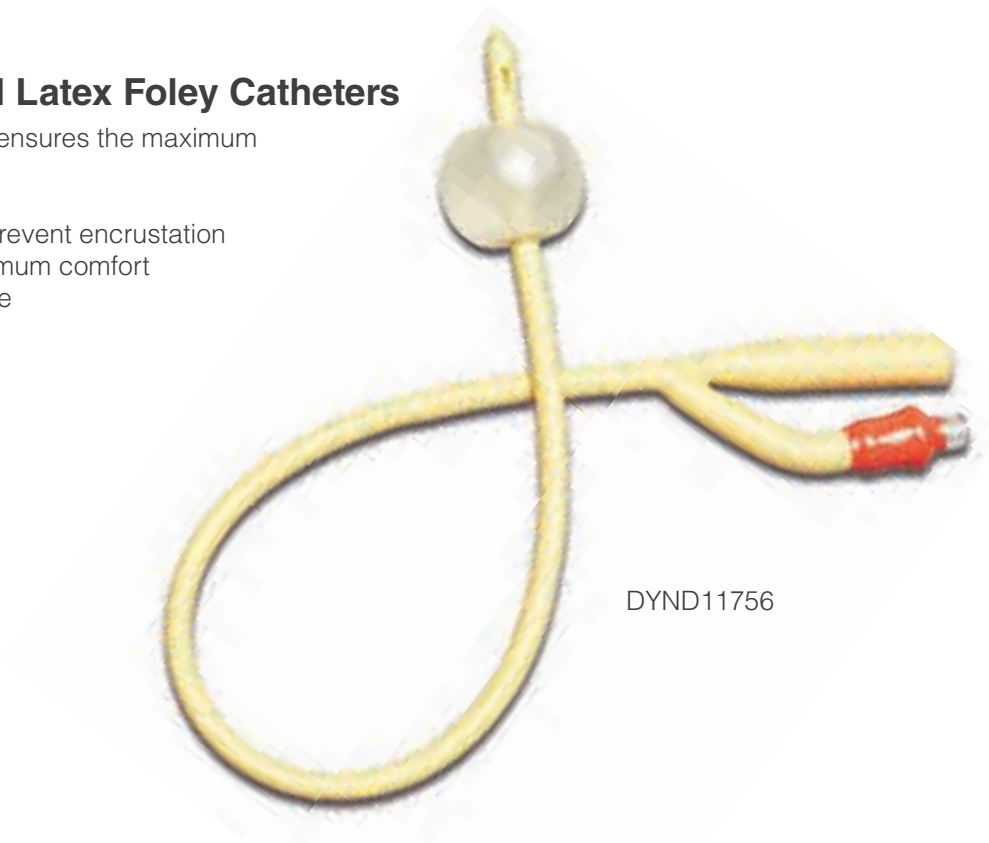

### 2-WAY SILICONE-ELASTOMER COATED LATEX FOLEY CATHETERS

ITEM NUMBER	SIZE	BALLOON SIZE	PKG	HCPCS
DYND11706	6 Fr	3 ml	12/cs	A4338
DYND11708	8 Fr	3 ml	12/cs	A4338
DYND11710	10 Fr	3 ml	12/cs	A4338
DYND11752	12 Fr	10 ml	12/cs	A4338
DYND11754	14 Fr	10 ml	12/cs	A4338
DYND11756	16 Fr	10 ml	12/cs	A4338
DYND11758	18 Fr	10 ml	12/cs	A4338
DYND11760	20 Fr	10 ml	12/cs	A4338
DYND11762	22 Fr	10 ml	12/cs	A4338
DYND11764	24 Fr	10 ml	12/cs	A4338
DYND11766	26 Fr	10 ml	12/cs	A4338
DYND11768	28 Fr	10 ml	12/cs	A4338
DYND11770	30 Fr	10 ml	12/cs	A4338
DYND11772	12 Fr	30 ml	12/cs	A4338
DYND11774	14 Fr	30 ml	12/cs	A4338
DYND11776	16 Fr	30 ml	12/cs	A4338
DYND11778	18 Fr	30 ml	12/cs	A4338
DYND11780	20 Fr	30 ml	12/cs	A4338
DYND11782	22 Fr	30 ml	12/cs	A4338
DYND11784	24 Fr	30 ml	12/cs	A4338
DYND11786	26 Fr	30 ml	12/cs	A4338
DYND11788	28 Fr	30 ml	12/cs	A4338
DYND11790	30 Fr	30 ml	12/cs	A4338



## Specialty Coude-Tip Silicone-Elastomer Coated Latex Foley Catheters

For difficult insertions, coude-tip Foley catheters feature a bent tip that maneuvers around obstructions leading to the bladder.

- Coating helps resist encrustation and aids in patient comfort
- Large smooth drainage eyes for maximum comfort



DYND11216

### 2-WAY COUDE-TIP SILICONE-ELASTOMER COATED LATEX FOLEY CATHETERS

ITEM NUMBER	SIZE	BALLOON SIZE	PKG	HPCPS
DYND11214	14 Fr	10 ml	12/cs	A4340
DYND11216	16 Fr	10 ml	12/cs	A4340
DYND11218	18 Fr	10 ml	12/cs	A4340
DYND11220	20 Fr	10 ml	12/cs	A4340

## 3-Way Silicone-Elastomer Coated Latex Foley Catheters

The 3-way Foley catheter adds continuous irrigation capabilities after bladder or other urinary surgeries.

- Medications or other solutions can be continuously introduced to the bladder
- If irrigation is discontinued, a catheter plug may be used to close the lumen (see DYND12200 on page 25)



DYND11802

### 3-WAY SILICONE-ELASTOMER COATED LATEX FOLEY CATHETERS

ITEM NO.	SIZE	BALLOON SIZE	PKG	HPCPS
DYND11800	16 Fr	30 ml	12/cs	A4346
DYND11801	18 Fr	30 ml	12/cs	A4346
DYND11802	20 Fr	30 ml	12/cs	A4346
DYND11803	22 Fr	30 ml	12/cs	A4346
DYND11804	24 Fr	30 ml	12/cs	A4346
DYND11805	26 Fr	30 ml	12/cs	A4346

## Lubricious Hydrophilic Latex Foley Catheters

The lubricious hydrophilic coating on both the inside and outside of the catheter absorbs body fluids and reduces irritation by forming a protective carrier between the catheter and urethral tissue.

- Superior lubricity for less urethral irritation
- Large smooth drainage eyes for maximum comfort

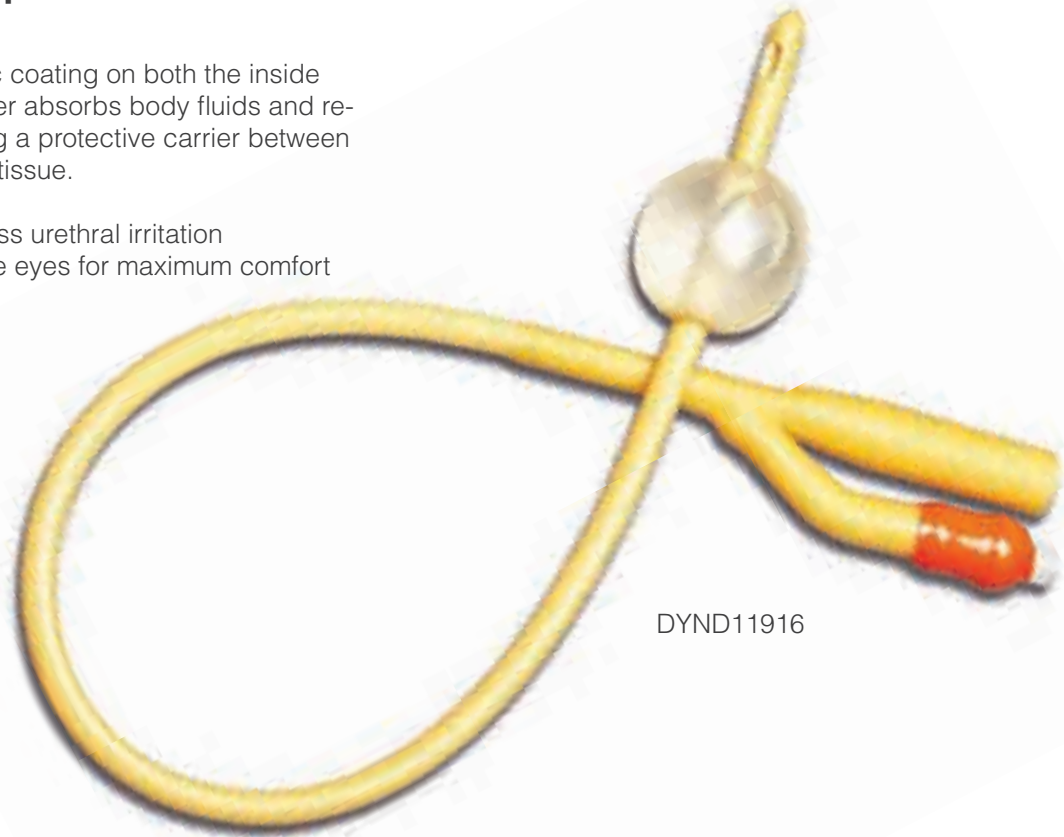

### 2-WAY LUBRICIOUS HYDROPHILIC LATEX FOLEY CATHETERS

ITEM NO.	SIZE	BALLOON SIZE	PKG	HCPCS
DYND11912	12 Fr	10 ml	12/cs	A4338
DYND11914	14 Fr	10 ml	12/cs	A4338
DYND11916	16 Fr	10 ml	12/cs	A4338
DYND11918	18 Fr	10 ml	12/cs	A4338
DYND11920	20 Fr	10 ml	12/cs	A4338
DYND11922	22 Fr	10 ml	12/cs	A4338
DYND11924	24 Fr	10 ml	12/cs	A4338
DYND11926	26 Fr	10 ml	12/cs	A4338
DYND11928	28 Fr	10 ml	12/cs	A4338
DYND11930	30 Fr	10 ml	12/cs	A4338
DYND11932	12 Fr	30 ml	12/cs	A4338
DYND11934	14 Fr	30 ml	12/cs	A4338
DYND11936	16 Fr	30 ml	12/cs	A4338
DYND11938	18 Fr	30 ml	12/cs	A4338
DYND11940	20 Fr	30 ml	12/cs	A4338
DYND11942	22 Fr	30 ml	12/cs	A4338
DYND11944	24 Fr	30 ml	12/cs	A4338
DYND11946	26 Fr	30 ml	12/cs	A4338
DYND11948	28 Fr	30 ml	12/cs	A4338
DYND11950	30 Fr	30 ml	12/cs	A4338



## SCIP-Inf-10 – Surgery Patients with Perioperative Temperature Management

The Centers for Medicare & Medicaid Services (CMS) adopted SCIP-Inf-10 in 2009. This measure requires acute care inpatient facilities to achieve a 36.0°C temperature in patients undergoing surgical procedures under general or neuraxial anesthesia for 60 minutes or more.<sup>1</sup>

### INTRODUCING — TWO PRODUCTS TO HELP PREVENT UNINTENTIONAL HYPOTHERMIA

1

#### Temperature Sensing Foley Catheters

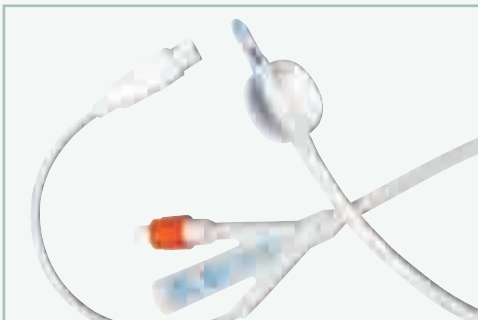

Medline's advanced Temperature Sensing Foley catheters help you comply with SCIP-Inf-10 by monitoring the patient's core temperature with an integrated thermistor.

The latex-free, 100% silicone catheter has a molded connector for a sealed, moisture-resistant, one-way fit.

See pages 16-17 of this brochure for more information on our Temperature Sensing Foley catheters.

2

#### PerfecTemp Patient Warming System



Medline's new PerfecTemp OR table pad helps meet SCIP-Inf-10 by combating hypothermia.

PerfecTemp's unique and reusable pads offer silent warming from underneath, allowing effective patient warming — even during C-sections and heart and spinal procedures.

For additional information, ask your sales representative, call 1-800-MEDLINE or visit us at [medline.com](http://medline.com)

## Temperature-Sensing Foley Catheters

400-Series Temperature-sensing Foley catheters help with compliance with SCIP-Inf-10. The 100% silicone catheter has an integrated thermistor that aids in monitoring the body's core temperature via the bladder. The connection port has a molded connector for a sealed, moisture-resistant, one-way fit.

- 8" side arm – a sealed electrical connection away from the patient
- Smooth tip – easy insertion without buckling
- +/- 0.2°C accuracy
- Fully compatible with most patient monitors

**NEW**  
Temperature-Sensing  
Foley Catheters



### 400-SERIES TEMPERATURE-SENSING FOLEY CATHETERS – LATEX FREE

ITEM NO.	SIZE	BALLOON SIZE	PKG
DYND110508	8 Fr	3 ml	10/cs
DYND110510	10 Fr	3 ml	10/cs
DYND110512	12 Fr	10 ml	10/cs
DYND110514	14 Fr	10 ml	10/cs
DYND110516	16 Fr	10 ml	10/cs
DYND110518	18 Fr	10 ml	10/cs

## Temperature-Sensing Cables

Interconnecting cables are made of a durable barrier to minimize interference

- All cables are 12' long
- Designed for compatibility with most monitors and anesthesia/hypothermia machines



DYND110102



Philips Adapter



DYND110101



1/4" Adapter



DYND110103



Siemens Adapter

### TEMPERATURE SENSING CABLES – LATEX FREE

ITEM NO.	DESCRIPTION	PKG
DYND110101	1/4" Adapter	10/cs
DYND110102	Philips Adapter	10/cs
DYND110103	Siemens Adapter	10/cs



## DRAIN BAGS

Medline drain bags feature our exclusive slide tap for easy one-handed drainage and a needleless sample port for safe urine sampling.

High-quality drain bags come in a variety of sizes and styles to meet your facility's needs. All Medline drain bags are 100 percent latex free.

Maximize patient dignity with our exclusive urinary drain bag covers.

Made of a blue nonwoven material, the disposable cover conceals drain bag fluids. It's easy to affix to the drain bag, and the open-end design allows for easy drainage.

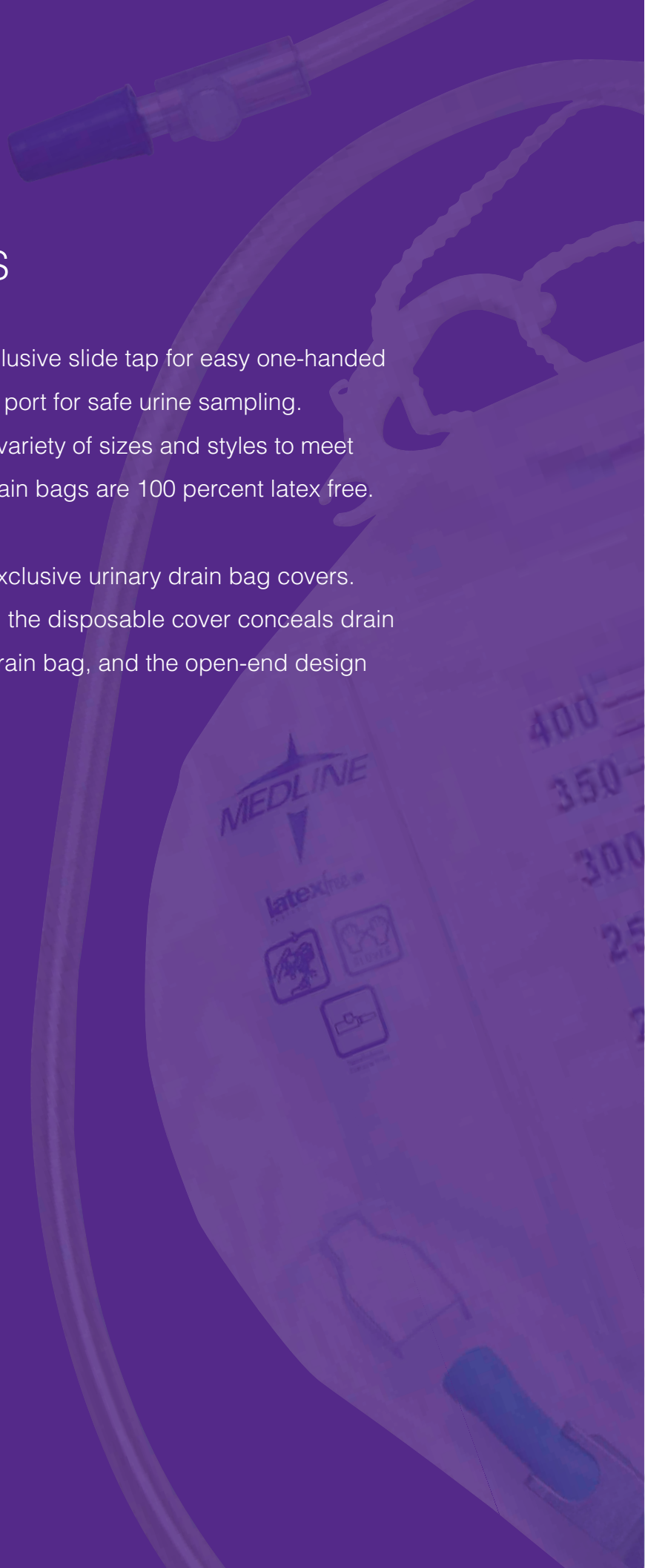

## IN THIS SECTION

Urine Meters .....	20
Drain Bags .....	21
Leg Bags .....	24
Drain Bag Covers .....	24
Accessories .....	25



## Urine Meters

Each Medline urine meter is packaged OR sterile in a Tyvek® peel pouch.

- Adjustable bed-sheet clamp for securing drain bag tubing
- Includes 9/32" tubing with either 60" or 48" length
- Drain bag capacity: 2,500ml or 2,000ml
- Accurately measure urine output
- Typically used on critically ill and surgical patients
- Needle-less sample port



DYND17403



DYND17407

### URINE METERS

ITEM NO.	DESCRIPTION	PKG	HCPCS
DYND17403	400 ml Urine Meter with 2,500 ml Drain Bag	10/cs	A4357
DYND27403	400 ml Urine Meter with 2,500 ml Drain Bag – Luer Lock	10/cs	
DYND17407	200 ml Urine Meter with 2,000 ml Drain Bag – Luer Lock	10/cs	

## Drain Bags

Only Medline Drain Bags have a slide tap for easy one-handed drainage. The needleless sample port was first designed by Medline and provides a safe way to take urine samples. Star tubing (50" x 11/32") facilitates drainage of thick, fibrous urine and resists kinking.

- Reinforced hanger with built-in anti-kink drain tube guide
- Adjustable bed sheet clamp for securing drain bag tubing
- Capacity: 2,000 ml or 4,000 ml

## Drain Bags with Anti-Reflux Tower

The urinary drain bag with anti-reflux tower provides reflux protection without mechanical parts to hinder flow.

- Non-wettable air filter to help prevent vacuum action and facilitate drainage
- 2,000ml capacity for standard use or 4,000ml capacity for use with continuous bladder irrigation
- Sterile Fluid Pathway



*Anti-reflux tower minimizes backflow and increases patient safety.*



DYND15405

### DRAIN BAGS WITH ANTI-REFLUX TOWER

ITEM NO.	DESCRIPTION	PKG	HCPCS
DYND15205	2,000 ml with Slide Tap Drainage Port	20/cs	A4357
DYND25205	2,000 ml with Slide Tap Drainage Port – Luer Lock	20/cs	
DYND15203	2,000 ml with Metal Clamp Drainage Port	20/cs	A4357
DYND15405	4,000 ml with Metal Clamp Drainage Port	20/cs	A4357



## Drain Bags with Anti-Reflux Device

The urinary drain bag with anti-reflux device has a one-way clear Mylar® valve for visualization of urine flow.

- Non-wettable air filter to help prevent vacuum action and facilitate drainage
- Foley Insetag® included for easy tracking of catheter days



Anti-reflux control with a 1-way mylar valve.



DYND15207

### DRAIN BAGS WITH ANTI-REFLUX DEVICE

ITEM NO.	DESCRIPTION	PKG	HCPCS
DYND15207	2,000 ml with Slide Tap Drainage Port	20/cs	A4357
DYND25207	2,000 ml with Slide Tap Drainage Port – Luer Lock	20/cs	
DYND15210	2,000 ml with Metal Clamp Drainage Port	20/cs	A4357

## Drain Bag with Anti-Reflux Valve

The drain bag includes a vinyl flap system that minimizes back flow into the drainage tubing.

- Allows free flow of fluid into the drain bag
- Exclusive slide-tap drainage
- Sterile fluid pathway



Slide-tap mechanism allows for easy, one-handed bag drainage.



DYNC1674

### DRAIN BAG WITH ANTI REFLUX VALVE

ITEM NO.	SIZE	PKG	HCPCS
DYNC1674	2,000 ml with Slide Tap Drainage Port	20/cs	A4357

## Low-Bed Drain Bag

The drain bag hangs only 7" (18 cm) to allow low placement on an adjustable bed without touching the floor

- Anti-reflux valve for back-flow prevention
- 50" of tubing to facilitate proper drainage
- Exclusive slide-tap drainage port allows for minimal splashing during drainage
- Reversible design for versatile placement on either side of the bed
- Sterile fluid pathway

See Low-Bed Drain Bag Cover on page 24.



DYND15215

### LOW BED DRAIN BAG

ITEM NO.	SIZE	PKG	HCPCS
DYND15215	1,200 ml with Slide Tap Drainage Port	20/cs	A4357

## Belly Bag

The revolutionary latex-free Belly Bag fastens comfortably around the waist. It's designed for patients who have an indwelling Foley or suprapubic catheter and can be easily worn 24 hours a day.

- Anti-reflux valve behind the catheter port
- Drain valve at the normal urethral position

### BELLY BAG – LATEX FREE

ITEM NO.	SIZE	PKG
LFTB1000	1,000 ml	10/cs
LFTB1000P	1,000 ml bag with sample port	10/cs

## Leg Bags

Anti-reflux valve in each leg bag helps prevent backflow.

- Twist valve for easy emptying and minimal spillage
- Slide tap allows for exceptional ease of use
- Latex-free elastic straps come preconnected to each bag
- Sterile fluid pathway



DYND12574

DYND12588

## LEG BAGS WITH PRE-ATTACHED STRAPS

ITEM NO.	DESCRIPTION	SIZE	PKG	HCPCS
DYND12574	Twist-Valve Drainage Port, 19 oz.	Medium, 600 ml	48/cs	A4358
DYND12575	Twist-Valve Drainage Port, 19 oz. with Extension Tubing (18")	Medium, 600 ml	48/cs	A4358
DYND12578	Twist Valve Drainage Port, 32 oz.	Large, 1,100 ml	48/cs	A4358
DYND12584	Fabric Back, Exclusive Slide-Tap Drainage Port, 19 oz.	Medium, 600 ml	48/cs	A4358
DYND12588	Fabric Back, Exclusive Slide-Tap Drainage Port, 32 oz.	Large, 1,100 ml	48/cs	A4358

## Drain Bag Covers

Improve patient dignity with Medline's exclusive urinary drain bag covers.

- Blue nonwoven material conceals the fluid in the drain bag
- Easy to affix to urinary drain bag
- Easy-access design allows for easy drainage
- Original design fits most urinary drain bags
- Low-bed design fits Medline's patented low bed drain bag (DYND15215)



DYND15200

DYND15200LOW

## DRAIN BAG COVERS

ITEM NO.	DESCRIPTION	FABRIC COLOR	PKG
DYND15200	Urinary Drain Bag Cover	Blue	20/cs
DYND15200LOW	Low Bed Drain Bag Cover	Blue	20/cs

## Accessories

Catheter plug fits securely into funnel end of most Foley catheters. Cover protects connector on drainage bag. With leg bags, extension tubing should be used. It can be cut to length to meet the patient's needs.



DYND12200

### ACCESSORIES

ITEM NO.	DESCRIPTION	PKG	HCPCS
DYND12550	Leg-Bag Extension Tubing, 18", Sterile, Latex Free	50/cs	A4331
DYND12200	Plug for Catheter Drainage Protector Tube, Sterile	100/cs	A9270

## Drain Bag Holder

- Made from durable poly/cotton
- Attaches to a wheel chair frame with 100% polyester straps
- Three separate snap positions for easy adjustment



### DRAIN BAG HOLDER

ITEM NO.	DESCRIPTION	PKG
MDT825150	Drain Bag Holder	each

## IV Pole with Drain Bag Hook

- Tool-Free Urine Bag Hook
- For use with Medline's IV Pole, item MDS80600



Tool-free Urine Bag Hook (MDS80600UBH), attaches easily to IV Pole (MDS80600) with a quick release lever.



### IV POLE WITH DRAIN BAG HOOK

ITEM NO.	DESCRIPTION	PKG
MDS80600UBH	Hook for Urine Bag on IV Pole	10/cs
MDS80600	IV Pole with Quick Release Casters	each



## IN THIS SECTION

Adhesive Securement Device .....	28
Adhesive Patch .....	29
Leg Straps .....	29



## Adhesive Securement Device

Keep the catheter securely in place and improve patient safety with our easy-to-use our Foley catheter tubing securement device.

- Adhesive patch with adjustable hook-and-loop securement prevents unnecessary pulls
- Packaged single sterile
- Securement device included in all of Medline's ERASE CAUTI trays



DYND7600FCL

### ADHESIVE SECUREMENT DEVICE

ITEM NO.	DESCRIPTION	SIZE	PKG	HCPCS
DYND7600FCL	Adhesive Securement Device	2" x 3" (5.1 cm x 7.6 cm) 50/cs		A4333



## Adhesive Patch

Medical grade adhesive patch for properly securing the Foley catheter.

- Safe and secure method of keeping catheter in place



DYND16700

### ADHESIVE PATCH

ITEM NO.	DESCRIPTION	SIZE	PKG	HCPCS
DYND16700	Adhesive Patch with Hook-and-Loop Holder for Catheter or Tube	2" x 3" (5.1 cm x 7.6 cm)	50/cs	A4333

## Leg Straps

Leg straps are available in multiple sizes depending on patient needs.

- Elastic comfort strap – stabilizes the catheter without restricting patient movement
- Foam catheter strap – holds catheter securely in place
- Hook-and-loop locking system – quick and easy to engage



DYND16900

### LEG STRAPS

ITEM NO.	DESCRIPTION	SIZE	PKG	HCPCS
DYND16800	Adjustable Foam, Hook-and-Loop Securement*	29" x 1.5" (73.7 cm x 3.8 cm)	12/bx	A4334
DYND16900	Elastic, Hook-and-Loop Securement*	22" x 2" (55.9 cm x 5.1 cm)	10/bx	A4334
DYND16905	Elastic, Hook-and-Loop Securement**	51" x 2" (129.5 cm x 5.1 cm)	10/bx	A4334

\*Fits Leg Circumferences up to 29"

\*\*Fits Leg Circumferences up to 65"



# CLOSED-SYSTEM TRAYS

CDC Category IB recommendations include following aseptic insertion of the urinary catheter and maintaining a closed drainage system.<sup>2</sup> Medline's Closed-System Trays have a sealed junction to help reduce bacterial introduction. Each tray includes Aloetouch 3G latex-free gloves, 3 PVP swabsticks, an underpad, a fenestrated drape, a prefilled inflation syringe, lubricant and a specimen container. Our innovative ERASE CAUTI one-layer tray design intuitively leads clinicians through the insertion process.

With Medline's Add-A-Cath and insertion trays, clinicians have the flexibility to choose the Foley catheter that's most appropriate for their patients.



## IN THIS SECTION

ERASE CAUTI Program . . . . .	32
ERASE CAUTI Foley Catheter Trays . . . . .	34
BioCon® 500 Bladder Scanner . . . . .	38
2-Layer Foley Catheter Trays . . . . .	39
Foley Catheter Insertion Trays . . . . .	43

# ERASE CAUTI

In section III of the CDC guidelines for CAUTI prevention, a Category IB recommendation for Proper Technique of Urinary Catheter Maintenance is as follows: “If the CAUTI rate is not decreasing after implementing a comprehensive strategy to reduce rates of CAUTI, consider using antimicrobial/antiseptic-impregnated catheters.”<sup>4</sup> Through education, awareness and products, the ERASE CAUTI Program provides a comprehensive strategy to support this high-priority CDC recommendation.

## THE PROGRAM INCLUDES:

- 1 An innovative tray designed to lead clinicians through the insertion process
- 2 Education program, including strategies to reduce CAUTI and a competency tool for clinicians
- 3 Awareness campaign: “The Race to ERASE CAUTI™”



# E

## Evaluate Indications

A unique removable sticker “flags” the clinician to identify if there is a valid clinical reason to catheterize.



# R

## Read Directions

The booklet on the outer package of the kit provides a clear step-by-step guide to catheter insertion and tips to help reduce CAUTI.



# A

## Aseptic Technique

The sequencing of products in our kit helps maintain proper technique.



# S

## Secure Catheter

The included catheter securement device can help reduce movement and urethral traction.



# E

## Educate The Patient

A convenient and eye-catching Patient Care Card is included in the kit to guide you through the process.



# ERASE CAUTI

## Innovative 1-Layer Foley Catheter Tray Design Leads Clinicians through the Insertion Process

Breakthrough, 1-layer Foley catheter tray design intuitively leads healthcare workers through established best practices. The unique, patented, design includes labeling and instructions, making it difficult for healthcare workers to do the wrong thing.

### THE TRAYS INCLUDE:

- Patient education card
- Foley securement device
- 3-pk PVP swabsticks
- 10 ml inflation syringe
- Lubricating jelly
- Specimen container
- Wrapped Aloetouch® 3G gloves
- Fenestrated drape
- Moisture-proof underpad
- Foley InserTag™
- Hand sanitizer packet

## COLOR-CODING

Colored bar at the top of each package differentiates the catheter/product inside the kit.

- Add-A-Cath
- Silvertouch® 100% Silicone Foley Catheter
- Silicone-Elastomer Coated Latex Foley Catheter
- 100% Silicone Foley Catheter
- 100% Silicone Temperature-Sensing

## ERASE CAUTI Add-A-Cath Trays

The Add-A-Cath tray allows clinicians to select the Foley catheter based on the patient's needs.

- Features Medline's 1-layer ERASE CAUTI tray to help ensure that best practices are followed
- Includes 10 ml inflation syringe and all necessary Foley catheter insertion components



### ADD-A-CATH TRAYS – LATEX FREE

ITEM NO.	DESCRIPTION	PKG
DYND160100	2,000 ml Drain Bag*	10/cs
DYND160200	400 ml Urine Meter with 2,500 ml Drain Bag*	10/cs

\*Foley catheter not included

## ERASE CAUTI Silvertouch® 100% Silicone Trays

Our patented process binds silver ions to the catheter's lubricious coating. The hydrophilic coating is covalently bonded to the catheter surface.

- Features Medline's 1-layer ERASE CAUTI tray to help ensure best practices are followed
- Hydrates quickly
- Maintains lubricity
- Helps reduce friction and irritation



### SILVERTOUCH 100% SILICONE TRAYS – LATEX FREE

ITEM NO.	DESCRIPTION	PKG	HCPCS
DYND160414	14 Fr 10 ml, with 2,000 ml Drain Bag	10/cs	A4315
DYND160416	16 Fr 10 ml, with 2,000 ml Drain Bag	10/cs	A4315
DYND160418	18 Fr 10 ml, with 2,000 ml Drain Bag	10/cs	A4315
DYND160514	14 Fr 10 ml, with 400 ml Urine meter with 2,500 ml Drain Bag	10/cs	A4315
DYND160516	16 Fr 10 ml, with 400 ml Urine Meter with 2,500 ml Drain Bag	10/cs	A4315
DYND160518	18 Fr 10 ml, with 400 ml Urine Meter with 2,500 ml Drain Bag	10/cs	A4315

## ERASE CAUTI Silicone-Elastomer Coated Latex Trays

Innovative manufacturing process produces the maximum amount of silicone coating available.

- Features Medline's 1-layer ERASE CAUTI tray to help ensure best practices are followed
- Slippery surface – reduces urethral trauma
- Silicone-elastomer coating – resists encrustation



### SILICONE ELASTOMER-COATED LATEX TRAYS

ITEM NO.	DESCRIPTION	PKG	HCPCS
DYND160114	14 Fr 10 ml, with 2,000 ml Drain Bag	10/cs	A4314
DYND160116	16 Fr 10 ml, with 2,000 ml Drain Bag	10/cs	A4314
DYND160118	18 Fr 10 ml, with 2,000 ml Drain Bag	10/cs	A4314
DYND160214	14 Fr 10 ml, with 400 ml Urine meter with 2,500 ml drain bag	10/cs	A4314
DYND160216	16 Fr 10 ml, with 400 ml Urine meter with 2,500 ml drain bag	10/cs	A4314
DYND160218	18 Fr 10 ml, with 400 ml Urine meter with 2,500 ml drain bag	10/cs	A4314



## ERASE CAUTI Coude Silicone-Elastomer Coated Latex Tray

For difficult insertions, coude-tip Foley catheters feature a bent tip that maneuvers around obstructions leading to the bladder.

- Featuring Medline's 1-layer ERASE CAUTI tray to help ensure that best practices are followed
- Large oval-shaped eye for maximum drainage
- Smooth reinforced tip resists buckling



### COUDE SILICONE-ELASTOMER COATED LATEX TRAY

ITEM NO.	DESCRIPTION	PKG
DYND160116C	16 Fr 10 ml Coude Foley Catheter Tray	10/cs

## ERASE CAUTI 100% Silicone Trays

Maximize safety and comfort with our 100% Silicone Foley catheters.

- Features Medline's 1-layer ERASE CAUTI tray to help ensure best practices are followed
- Completely inert for less tissue irritation and encrustation during extended periods of indwelling use
- Bullet-shaped tip for easier insertion and less buckling
- Large, smooth eyes for maximum comfort



### 100% SILICONE TRAYS – LATEX FREE

ITEM NO.	DESCRIPTION	PKG	HCPCS
DYND160714	14 Fr 10 ml, with 2,000 ml Drain Bag	10/cs	A4315
DYND160716	16 Fr 10 ml, with 2,000 ml Drain Bag	10/cs	A4315
DYND160718	18 Fr 10 ml, with 2,000 ml Drain Bag	10/cs	A4315
DYND160814	14 Fr 10 ml, with 400 ml Urine Meter with 2,500 ml Drain Bag	10/cs	A4315
DYND160816	16 Fr 10 ml, with 400 ml Urine Meter with 2,500 ml Drain Bag	10/cs	A4315
DYND160818	18 Fr 10 ml, with 400 ml Urine Meter with 2,500 ml Drain Bag	10/cs	A4315

## ERASE CAUTI 100% Silicone Temperature-Sensing Trays

Temperature sensing catheter helps clinicians continuously monitor a patient's core body temperature via the bladder.

- Features Medline's 1-layer ERASE CAUTI tray to help ensure best practices are followed
- $\pm 0.2^{\circ}\text{C}$  accuracy
- Pediatric and adult sizes



### 400 SERIES TEMPERATURE-SENSING TRAYS – LATEX FREE

ITEM NO.	DESCRIPTION	PKG
DYND160814T	14 Fr 10 ml, with 400 ml Urine Meter with 2,500 ml Drain Bag	10/cs
DYND160816T	16 Fr 10 ml, with 400 ml Urine Meter with 2,500 ml Drain Bag	10/cs
DYND160818T	18 Fr 10 ml, with 400 ml Urine Meter with 2,500 ml Drain Bag	10/cs



## ERASE CAUTI 100% Silicone Pediatric Foley Catheter Trays

Child Life experts tell us that providing a child with a stuffed toy during an unpleasant procedure is an excellent way to help them cope.<sup>5</sup> Now Buddy the Brave™ is here to help. Featured on Medline's new ERASE CAUTI pediatric catheter trays, he provides valuable education for parents and advocates, as well as a fun activity card and sticker for kids.

### KIT INCLUDES:

- Aloetouch® 3G gloves
- Foley Insetag
- Hand sanitizer
- Underbuttocks drape
- Fenestrated drape
- Lubricating jelly syringe
- Sterile water syringe
- Specimen container
- 3-pack PVP swabsticks
- Pediatric securement device
- Exact measure urine meter



*Pediatric Foley Catheter Tray*

*Bravery Sticker*

*Children's Activities*

CLOSED-SYSTEM TRAYS

## ERASE CAUTI 100% Silicone Pediatric Foley Catheter Trays

- Buddy the Brave is on the label, so you know it's kid-friendly
- Pediatric activity education card
- Pediatric 200 ml urine meter connected to 2,000 ml drain bag

100% SILICONE PEDIATRIC FOLEY TRAYS – LATEX FREE

ITEM NO.	DESCRIPTION	PKG
DYND160806	6 Fr 1.5 ml	10/cs
DYND160808	8 Fr 3 ml	10/cs
DYND160810	10 Fr 3 ml	10/cs

400 SERIES TEMPERATURE-SENSING PEDIATRIC FOLEY TRAYS – LATEX FREE

ITEM NO.	DESCRIPTION	PKG
DYND160808T	8 Fr 3 ml	10/cs
DYND160810T	10 Fr 3 ml	10/cs

## BioCon® 500 Bladder Scanner

Helps in determining if catheterization is necessary. The BioCon 500 scanner measures post void residual (PVR) urine volume and screens for many common urological conditions. Similar to an ultrasound machine, the scanner displays an image of the bladder on the screen when a clinician positions the wand over the area using a clear gel. The device is portable for easy transport to the patient's bedside.

**EXCLUSIVELY  
from Medline**

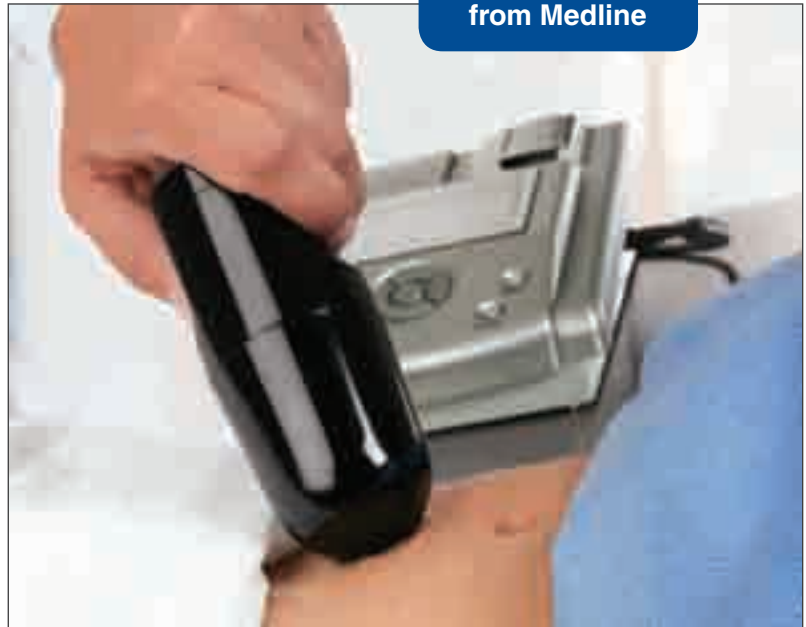

### **BENEFITS OF REDUCING CATHETERIZATIONS:**

- Preserve patient dignity
- Increase compliance with SHEA Guidelines for managing urinary retention<sup>6</sup>
- Decrease total expenses
- Eliminate catheter-associated discomfort and potential risks of CAUTI
- Save staff time – requires little training



*Unique pre-scan feature improves accuracy by ensuring entire bladder is being scanned and saves time by not having to redo an improper scan.*



### ORDERING INFORMATION

ITEM NO.	DESCRIPTION	PKG
MDSB10500	BioCon-500 Bladder Scanner	each
MDS3110100032	Mobile Stand and Basket	each
MDS092005	Ultrasound Gel	each

*"Not for fetal use or use on pregnant patients."*

## 2-Layer Foley Catheter Trays

Sealed junction reduces the chance of bacterial introduction and secures the Foley catheter to the drainage tubing. Urine bag drainage port has a slide-tap valve with a “see through” drain tube.

## 2-Layer Add-A-Cath Foley Catheter Trays

Sterile, latex-free Add-A-Cath trays contain all the necessary supplies to prepare for catheter insertion:

- Compartmentalized prep tray
- Aloetouch 3G latex-free wrapped gloves
- 3 pre-saturated PVP swabsticks
- Moistur e-proof underpad
- Fenestrated drape
- Sterile water syringe
- Lubricating jelly
- Specimen container with label
- 2,000 ml drain bag with anti-reflux tower



### ADD-A-CATH FOLEY TRAYS – LATEX FREE

ITEM NO.	DESCRIPTION	INFLATION SYRINGE SIZE	PKG	HCPCS
DYND11090	2,000 ml Drain Bag with Anti-Reflux Tower	10 ml	10/cs	A4354
DYND11095	2,000 ml Drain Bag with Anti-Reflux Tower	30 ml	10/cs	A4354



## 2-Layer Silicone-Elastomer Coated Latex Foley Catheter Trays

Silicone-elastomer coated latex trays feature a latex Foley catheter pre-connected to a drainage bag or urine meter. All necessary components for proper Foley catheter insertion are included.

- Innovative manufacturing process – the maximum amount of silicone coating available
- Internally and externally coated latex catheter – resists encrustation and bacterial colonization



### SILICONE-ELASTOMER COATED LATEX FOLEY CATHETER TRAYS

ITEM NO.	DESCRIPTION	PKG	HCPCS
DYND11003	16 Fr 10 ml, with 2,000 ml Drain Bag with Anti-Reflux Tower	10/cs	A4314
DYND11008	18 Fr 10 ml, with 2,000 ml Drain Bag with Anti-Reflux Tower	10/cs	A4314
DYND1516SEC	16 Fr 10 ml, with 400 ml Urine Meter with 2,500 ml Drain Bag	10/cs	A4314
DYND1518SEC	18 Fr 10 ml, with 400 ml Urine Meter with 2,500 ml Drain Bag	10/cs	A4314

## 2-Layer Lubricious Hydrophilic Latex Foley Catheter Trays

Lubricious hydrophilic latex trays feature a latex Foley catheter pre-connected to a 2,000 ml drainage bag with anti-reflux tower. All the necessary components for proper Foley catheter insertion are included.

- Hydrophilic coating on the latex catheter reduces irritation and trauma

### LUBRICIOUS HYDROPHILLIC LATEX FOLEY CATHETER TRAYS

ITEM NO.	DESCRIPTION	PKG	HCPCS
DYND11903	16 Fr 10 ml, with 2,000 ml Drain Bag with Anti-Reflux Tower	10/cs	A4314
DYND11908	18 Fr 10 ml, with 2,000 ml Drain Bag with Anti-Reflux Tower	10/cs	A4314

## 2-Layer Silvertouch 100% Silicone Foley Catheter Trays

Patented Silvertouch 100% silicone Foley trays feature a Silvertouch Foley catheter pre-connected to a Medline drain bag. The brilliant color on the Silvertouch catheter is proof of the silver hydrophilic coating - ensuring a full week's worth of comfort. All the necessary components for proper Foley catheter insertion are included.

- Helps to reduce friction and irritation
- Covalently bonded coating will not peel, flake, or crack



### SILVERTOUCH 100% SILICONE FOLEY CATHETER TRAYS – LATEX-FREE

ITEM NO.	DESCRIPTION	PKG	HCPCS
DYND140214	14 Fr 10 ml, with 2,000 ml Drain Bag with Anti-Reflux Device	10/cs	A4315
DYND140216	16 Fr 10 ml, with 2,000 ml Drain Bag with Anti-Reflux Device	10/cs	A4315
DYND140218	18 Fr 10 ml, with 2,000 ml Drain Bag with Anti-Reflux Device	10/cs	A4315
DYND140416	16 Fr 10 ml, with 400 ml Urine Meter with 2,500 ml Drain Bag	10/cs	A4315
DYND140418	18 Fr 10 ml, with 400 ml Urine Meter with 2,500 ml Drain Bag	10/cs	A4315



## 2-Layer 100% Silicone Foley Catheter Trays

100% Silicone trays feature a Foley catheter pre-connected to a Medline drain bag. All the necessary components for proper Foley catheter insertion are included.

- 100% Silicone foley catheter designed for maximum drainage
- Foley catheter has a symmetrical balloon for reliability
- Designed for maximum drainage
- Strong symmetrical balloons for reliability



### 100% SILICONE FOLEY CATHETER TRAYS – LATEX FREE

ITEM NO.	DESCRIPTION	PKG	HCPCS
DYND11523	16 Fr 10 ml, 2,000 ml Drain Bag with Anti-Reflux Tower	10/cs	
DYND11528	18 Fr 10 ml, 2,000 ml Drain Bag with Anti-Reflux Tower	10/cs	
DYND1516SIL	16 Fr 10 ml, Urine Meter with 2,500 ml Drain Bag	10/cs	A4315
DYND1518SIL	18 Fr 10 ml, Urine Meter with 2,500 ml Drain Bag	10/cs	A4315

## Foley Catheter Insertion Trays

Medline Foley Insertion Trays provide the freedom and flexibility to choose the drain bag and catheter to fit the needs of each patient.

### ALL KITS INCLUDE:

- Graduated basin
- Latex-free gloves
- Underpad
- Fenestrated drape
- Sterile water inflation syringe
- Lubricating jelly packet



Item No.	Peel-lid tray	CSR wrapped tray	10 ml syringe	30 ml syringe	PVP Swab-stick 3/pk	BZK Swab-stick 3/pk	Aloetouch 3G gloves	Vinyl gloves	Specimen Container	Pkg	HCPCS
DYNC1810	•		•		•			•		20/cs	A4310
DYNC1814	•			•		•		•		20/cs	A4310
DYNC1815	•			•	•			•		20/cs	A4310
DYND10160		•	•		•		•		•	20/cs	A4310
DYND10200		•		•	•		•			20/cs	A4310
DYND18100		•	•		•		•			20/cs	A4310
DYND10150*		•	•		•		•		•	20/cs	A4311

\*DYND10150 also contains a 16FR 10ml Silicone-Elastomer Latex Foley Catheter



## ALTERNATIVES TO FOLEY CATHETERS

There are many alternatives to long-term indwelling catheterization. Medline offers a variety of latex and latex-free intermittent catheters in a wide range of materials, configurations and French sizes. Additional product alternatives, such as the My-Cath Touch Free Self-Catheter system and a variety of male external catheters, are also available.

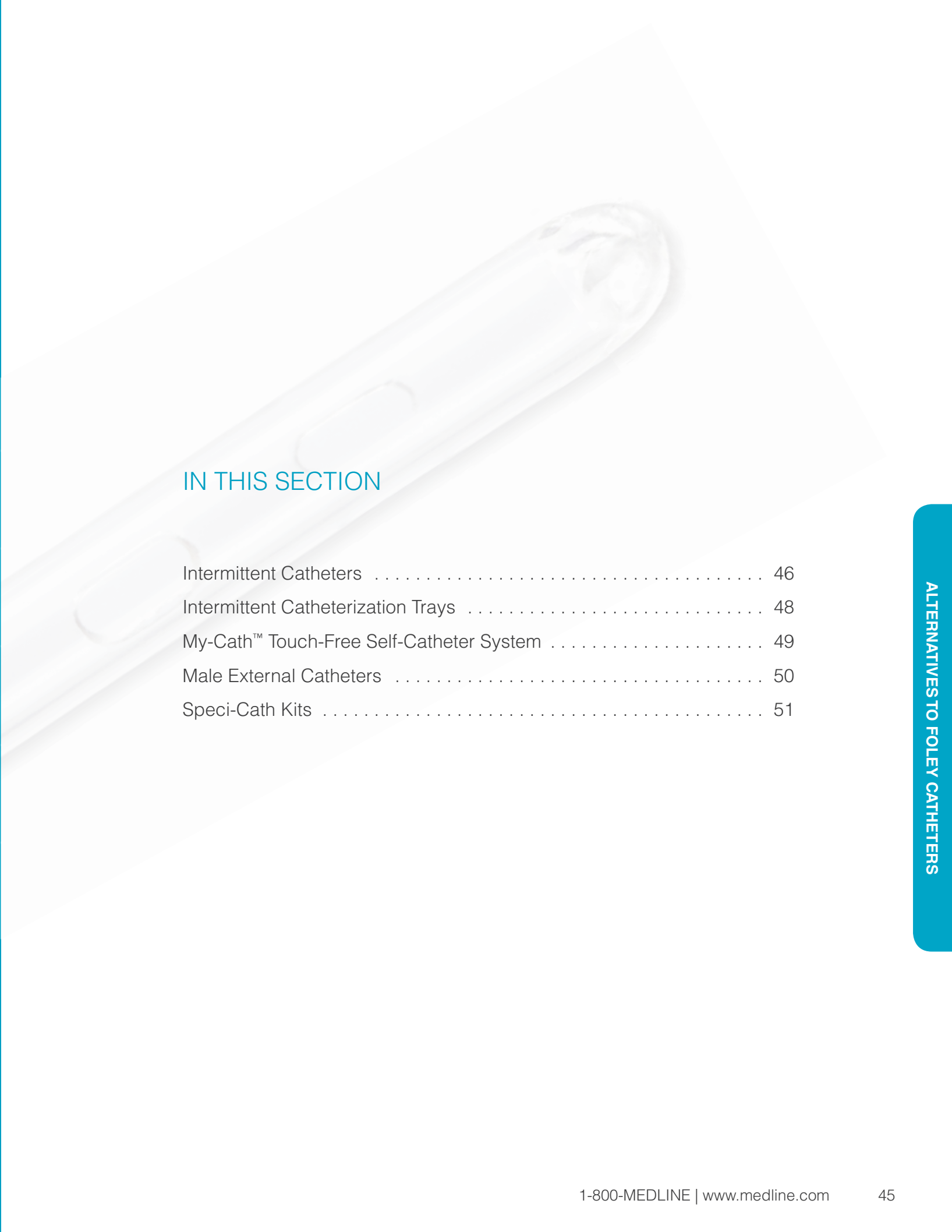

## IN THIS SECTION

Intermittent Catheters .....	46
Intermittent Catheterization Trays .....	48
My-Cath™ Touch-Free Self-Catheter System .....	49
Male External Catheters .....	50
Speci-Cath Kits .....	51

## Intermittent Catheters

Medline intermittent catheters are made with care and precision. The catheters are available in a wide selection of materials, configurations and French sizes. Available in female, pediatric and universal lengths.

- Smooth tip for easy insertion and comfort
- Staggered eyes for maximum flow
- Funnel end for ease of handling
- Various lengths



*Smooth eyes minimize urethral trauma. Clear vinyl intermittent catheter shown (item no. DYND10702).*

## Clear Vinyl Intermittent Catheters – Latex Free



6" Female Catheter available in 10, 12 and 14Fr



10" Pediatric Catheter available in 6, 8 and 10Fr



16" Male/Universal Catheter available in 10, 12, 14, 16 and 18Fr

### CLEAR VINYL CATHETERS – LATEX FREE

ITEM NO.	DESCRIPTION	SIZE	PKG	HCPCS
DYND10701	Female, 6"	10 Fr	30/cs	A4351
DYND10702	Female, 6"	12 Fr	30/cs	A4351
DYND10703	Female, 6"	14 Fr	30/cs	A4351
DYND10712	Pediatric, 10"	6 Fr	30/cs	A4351
DYND10713	Pediatric, 10"	8 Fr	30/cs	A4351
DYND10714	Pediatric, 10"	10 Fr	30/cs	A4351
DYND10721	Male/Universal, 16"	10 Fr	30/cs	A4351
DYND10722	Male/Universal, 16"	12 Fr	30/cs	A4351
DYND10723	Male/Universal, 16"	14 Fr	30/cs	A4351
DYND10700	Male/Universal, 16"	14 Fr	100/cs	A4351
DYND10724	Male/Universal, 16"	16 Fr	30/cs	A4351
DYND10725	Male/Universal, 16"	18 Fr	30/cs	A4351

## Red Rubber Latex All-Purpose Intermittent Catheters

Medline red rubber catheters are made with care and precision. Choose from a wide selection of configurations and French sizes.

- Smooth tip and funnel end made from a radiopaque material
- Two large opposing eyes for optimum drainage
- Suitable for male or female catheterization
- Latex free poly cath available
- Coude tip available
- 16" length

DYND13514

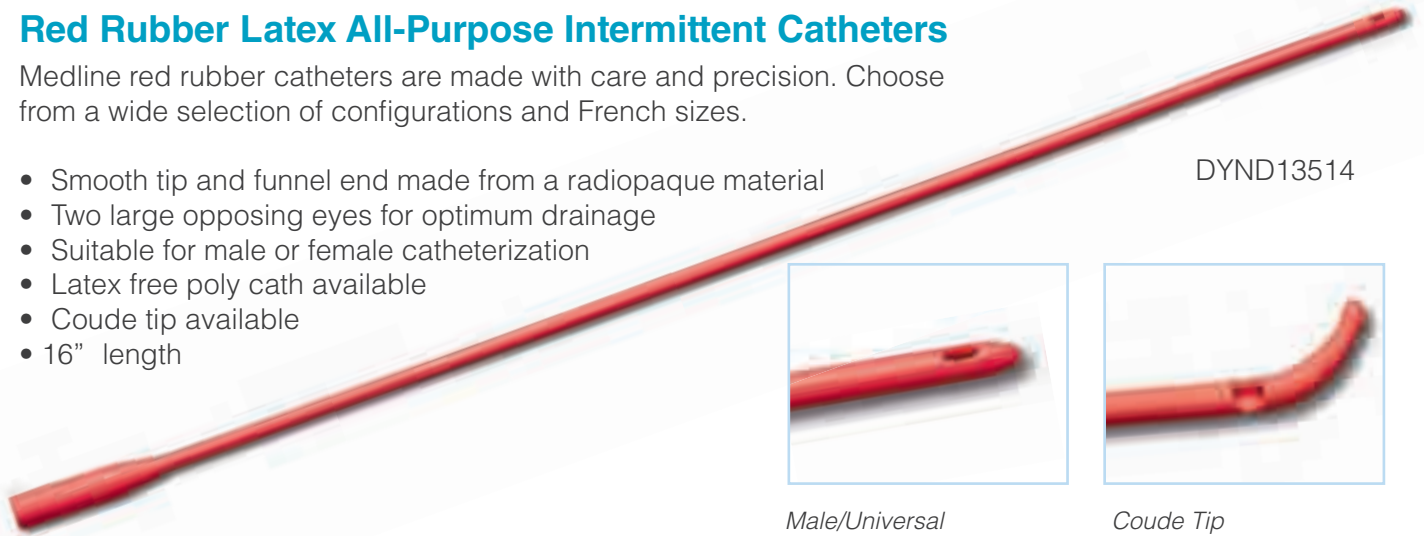

Male/Universal

Coude Tip

### RED RUBBER INTERMITTENT CATHETERS – MALE/UNIVERSAL

ITEM NO.	DESCRIPTION	SIZE	PKG	HCPCS
DYND13508	Male/Universal	8 Fr	12/cs	A4351
DYND13510	Male/Universal	10 Fr	12/cs	A4351
DYND13512	Male/Universal	12 Fr	12/cs	A4351
DYND13514	Male/Universal	14 Fr	12/cs	A4351
DYND13515	Male/Universal	15 Fr	50/cs	A4351
DYND13516	Male/Universal	16 Fr	12/cs	A4351
DYND13518	Male/Universal	18 Fr	12/cs	A4351
DYND13520	Male/Universal	20 Fr	12/cs	A4351
DYND13522	Male/Universal	22 Fr	12/cs	A4351

### RED RUBBER INTERMITTENT CATHETERS – COUDE TIP

ITEM NO.	DESCRIPTION	SIZE	PKG	HCPCS
DYND13614	Coude Tip	14 Fr	12/cs	A4352

## Red Poly-Cath Intermittent Catheter

Medline poly-catheter has the same flexibility and feel as a red rubber catheter, but is 100% latex free.

- Made of polyethylene and polyurethane
- Features the same feel as a red rubber catheter
- 16" length



Smooth tip and oval eyes, for exceptional patient comfort.



### RED POLY CATHETERS – LATEX FREE

ITEM NO.	DESCRIPTION	SIZE	PKG	HCPCS
DYND13714	Male/Universal	14 Fr	10/cs	A4351



## Intermittent Catheterization Trays

Medline intermittent catheterization trays provide you with all of the necessary supplies required for catheterization.

### ALL KITS INCLUDE:

- Graduated basin
- Latex-free gloves
- Underpad
- Fenestrated drape
- Swabsticks (3/pk)
- Lubricating jelly
- Specimen container with label



DYND10305

Item No.	Peel-lid tray	CSR wrapped tray	Red Rubber Catheter	Vinyl Catheter	PVP Swabsticks 3/Pk	BZK Swabsticks 3/Pk	Aloetouch 3G gloves	Vinyl gloves	Pkg	HCPCS
DYNC1820	•			14 Fr	•			•	20/cs	A4353
DYNC1816	•		15 Fr		•			•	20/cs	A4353
DYND10300		•		14 Fr	•		•		20/cs	A4353
DYND10305		•	No Cath	No Cath	•		•		20/cs	A4310
DYND10350		•	15 Fr		•		•		20/cs	A4353
DYND10500		•		14 Fr		•	•		20/cs	A4353

## Pre-Connected Intermittent Catheter Trays

All the necessary components available in order to complete an intermittent catheterization, with the additional benefit of a pre attached 1,000 ml drain bag. Available with a latex or latex-free catheter.

### ALL KITS INCLUDE:

- Aloetouch 3G gloves
- Underpad
- Fenestrated drape
- 3 pack of PVP swabsticks
- Lubricating jelly
- Specimen container with label



### PRE-CONNECTED INTERMITTENT CATHETER TRAYS

ITEM NO.	DESCRIPTION	SIZE	PKG	HCPCS
DYND10400	Graduated Basin, Clear Vinyl Catheter, Latex Free	14 Fr	20/cs	A4353
DYND10402	Compact Packaging, Clear Vinyl Catheter, Latex Free	14 Fr	20/cs	A4353
DYND10407	Compact Packaging, Red Rubber Catheter	15 Fr	20/cs	A4353

## My-Cath™ Touch-Free Self-Catheter System

The self-catheterization kit is ideal for active and independent patients. The closed system design reduces mess, eases disposal and reduces contamination risk by allowing a touch-free catheterization. The 14Fr catheter and introducer are coated with a water soluble lubricant for ease of insertion.

### CONTAINS:

- Catheter guide – allows for simple, protected control of catheter during insertion
- 1,500 ml collection bag – eliminates the need for a separate container, reducing the chance of spillage
- Moistur e-proof underpad
- W rapped gloves
- 3 pack of PVP swabsticks



DYND10440

### MY-CATH TOUCH-FREE SELF CATHETER SYSTEM

ITEM NO.	DESCRIPTION	SIZE	PKG	HCPCS
DYND10440	My-Cath Kit	14 Fr	20/cs	A4353

## Male External Catheters

Medline offers a variety of options for male external catheters. Available in both latex and latex free versions, these external catheters stay secure to the patient and get the job done.

### Exo-Cath® External Catheters

Flexible latex male external catheters include double-sided adhesive tape for proper securement.



DYND12302

#### EXO-CATH® EXTERNAL CATHETERS

ITEM NO.	DESCRIPTION	SIZE	PKG	HCPCS
DYND12303	Latex Exo-Cath, Small	25 mm	25/cs	A4349
DYND12302	Latex Exo-Cath, Medium	30 mm	25/cs	A4349
DYND12301	Latex Exo-Cath, Large	35 mm	25/cs	A4349

### 100% Silicone External Catheters

Avoid allergic reactions to latex proteins with 100% silicone male external catheters.

- Wide band – provides maximum security with non-sensitizing adhesive on nearly the entire sheath wall, helping to prevent urine migration and build up
- Ultraflex - built in adhesive band increases patient comfort and ease of application
- High-quality adhesive aids in securement.



RCH36301

#### 100% SILICONE EXTERNAL CATHETERS – LATEX FREE

ITEM NO.	DESCRIPTION	SIZE	PKG	HCPCS
RCH36301	Wide Band, Small	25 mm	30/cs	A4349
RCH36302	Wide Band, Medium	29 mm	30/cs	A4349
RCH36303	Wide Band, Intermediate	32 mm	30/cs	A4349
RCH36304	Wide Band, Large	36 mm	30/cs	A4349
RCH36305	Wide Band, X-Large	41 mm	30/cs	A4349
RCH33301	UltraFlex®, Small	25 mm	30/cs	A4349
RCH33302	UltraFlex, Medium	29 mm	30/cs	A4349
RCH33303	UltraFlex, Intermediate	32 mm	30/cs	A4349
RCH33304	UltraFlex, Large	36 mm	30/cs	A4349
RCH33305	UltraFlex, X-Large	41 mm	30/cs	A4349

## Speci-Cath Kits

Medline's Speci-Cath kits provide an easy way to collect a sterile urine sample. The minimally invasive catheter is pre-inserted into the specimen tube to ensure sterile technique. Available in neonatal, pediatric, female and universal/male sizes.

### Speci-Cath Kits

Medline's Speci-Cath kits provide an easy way to collect a sterile urine sample. The minimally invasive catheter is pre-inserted into the specimen tube to ensure sterile technique. Available in kits, which also contain, gloves, PVP swabsticks and lubricating jelly.

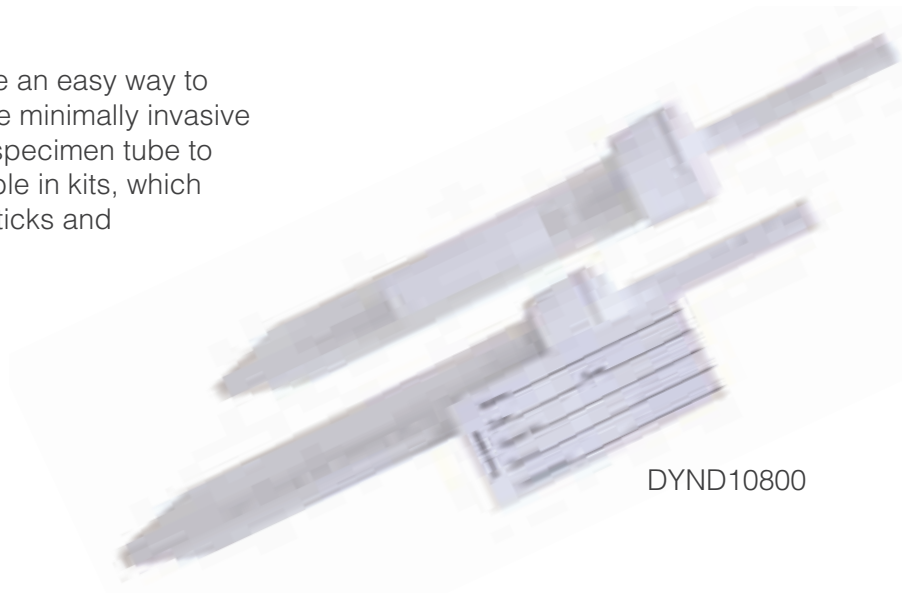

DYND10800

#### SPECI-CATH KITS – LATEX FREE

ITEM NO.	SIZE	CATHETER LENGTH	ALOETOUCH 3G GLOVES	3/PK PVP SWABSTICKS	LUBRICATING JELLY	PKG	HCPCS
DYND10800 8	Fr	6.5"				25/cs	A9270
DYND10805 8	Fr	6.5"	•	•	• 25/cs		A9270
DYND10806 8	Fr	6.5"	•	•		25/cs	A9270
DYND10810 8	Fr	14"	•	•	• 25/cs		A9270



## TRICS

Medline is committed to creating new and innovative urological products specific to the pediatric patient population. From our pediatric Foley catheters, available in 6, 8 and 10 Fr sizes, with 1.5 ml and 3 ml balloons, to the newly designed exact measure urine meter, Medline is constantly creating products to specifically fit pediatric needs.





## IN THIS SECTION

Buddy the Brave™ ERASE CAUTI® Trays . . . . .	54
Buddy the Brave™ ERASE CAUTI® Temperature Sensing Trays . . . . .	56
Pediatric Foley Catheters . . . . .	57
Exact Measure Pediatric Urine Meter . . . . .	58
Infant Urine Collectors . . . . .	58
Speci-Cath Kits . . . . .	59
Vinyl Intermittent Catheters . . . . .	59





## Buddy the Brave ERASE CAUTI Trays

**Introducing Medline's new Pediatric Catheter Tray.**

**The latest addition to the innovative ERASE CAUTI product line.**

Sometimes, you just need a buddy. Buddy the Brave lion cub is here to help your youngest catheter patients. Along with some serious patient (and parent/guardian) educational resources, you'll find fun, upbeat activities and a bravery award sticker in the every tray.

But it's more than just fun. There's published evidence that distraction helps children tolerate unpleasant procedures better than adult reassurance does; the enclosed bravery sticker and activity card are just the right distraction.

*Pediatric  
Catheter  
Tray*



*Bravery  
Sticker*

*Children's  
Activities*



## ERASE CAUTI Buddy the Brave 100% Silicone Trays

Buddy the Brave is on the label, so you know it's kid-friendly. Sharp photography of the kit contents lets you know what's inside, and the illustrated instructions can be reviewed without opening the pack. The one-layer tray design holds all the equipment you need for a procedure in a logical, "best practices" order.

### Kits Include:

- Aloetouch® 3G gloves
- Fenestrated drape
- 3-pack PVP Swabsticks
- Foley Insetag
- Lubricating jelly syringe
- Pediatric securement device
- Hand sanitizer
- Sterile water syringe
- Exact measure urine meter
- Underbuttocks drape
- Specimen container



DYND160806

### BUDDY THE BRAVE 100% SILICONE PEDIATRIC TRAYS – LATEX-FREE

ITEM NO.	DESCRIPTION	PKG
DYND160806	6 Fr 1.5 ml	10/cs
DYND160808	8 Fr 3 ml	10/cs
DYND160810	10 Fr 3 ml	10/cs

## ERASE CAUTI Buddy the Brave 100% Silicone Temperature Sensing Trays

Introducing the world's first temperature-sensing closed-system tray specifically designed for pediatric patients. Medline's revolutionary Buddy the Brave tray is now available with our 100% silicone 400-series temperature-sensing Foley catheter. It can detect a patient's core body temperature with +/- 0.2° C accuracy while maintaining urine flow. Buddy the Brave tray comes with a coloring and activity card and colorful sticker to help distract pediatric patients during the procedure.



DYND160808T



DYND110510

*100% silicone catheter has an integrated thermistor which aids in monitoring the patient's core body temperature via the bladder.*

### 400-SERIES TEMPERATURE SENSING TRAYS – LATEX FREE

ITEM NO.	DESCRIPTION	PKG
DYND160808T	8 Fr 3 ml 200 ml Urine Meter with 2000 ml Drain Bag	10/cs
DYND160810T	10 Fr 3 ml 200 ml Urine Meter with 2000 ml Drain Bag	10/cs

### 400-SERIES TEMPERATURE-SENSING FOLEY CATHETERS – LATEX FREE

ITEM NO.	SIZE	BALLOON SIZE	PKG
DYND110508	8 Fr	3 ml	10/cs
DYND110510	10 Fr	3 ml	10/cs

## Pediatric 100% Silicone Foley Catheters

Medline's pediatric Foley catheters are available in 6, 8 and 10 Fr sizes with 1.5 ml and 3 ml balloons and short lengths for pediatric use. Completely inert catheters minimize tissue irritation during extended periods of indwelling use.

- Pliable catheter with a firm tip – eases insertion
- Large, smooth eyes – maximum comfort and drainage
- Symmetrical balloon – added reliability



100% SILICONE FOLEY CATHETERS – LATEX FREE

ITEM NO.	SIZE	BALLOON SIZE	PKG	HCPCS
DYND11552	6 Fr	1.5 ml	10/cs	A4344
DYND11553	8 Fr	3 ml	10/cs	A4344
DYND11554	10 Fr	3 ml	10/cs	A4344

## Silicone-Elastomer Coated Latex Foley Catheters

Innovative manufacturing process provides the maximum amount of silicone coating available to increase patient comfort. Shortened length, specifically for pediatric patients.

- Silicone-elastomer coating – resists encrustation
- Symmetrical balloon for added reliability
- Includes stylet



SILICONE-ELASTOMER COATED LATEX FOLEY CATHETERS

ITEM NO.	SIZE	BALLOON SIZE	PKG	HCPCS
DYND11706	6 Fr	3 ml	12/cs	A4338
DYND11708	8 Fr	3 ml	12/cs	A4338
DYND11710	10 Fr	3 ml	12/cs	A4338



## Exact Measure Pediatric Urine Meter

Specifically designed for the pediatric patient population, the exact measure urine meter has 1 ml graduations for easy reading of output measurements.

- 200 ml urine meter with 2,000 ml drain bag
- Exclusive slide tap drainage port
- 48” of tubing for direct flow into the bag
- Needle-less access port

DYND17407



EXACT MEASURE PEDIATRIC URINE METER – LATEX FREE

ITEM NO.	DESCRIPTION	PKG
DYND17407	200 ml Urine Meter with 2,000 ml Drain Bag	10/cs

## Infant Urine Collector

The versatile infant urine collector can be used with both male and female infants.

- Adhesive is gentle on skin and easy to remove, yet holds securely
- Folds to form a spill-proof specimen transport
- Available in both sterile and non-sterile packaging

MDS190510



INFANT URINE COLLECTORS – LATEX FREE

ITEM NO.	DESCRIPTION	SIZE	PKG	HCPCS
MDS190505	Non-Sterile Pediatric Urine Collector	5 oz. (150 ml)	50/bx	A4328
MDS190510	Sterile Pediatric Urine Collector	5 oz. (150 ml)	50/bx	A4328

## Speci-Cath Kits

Medline's Speci-Cath kits provide an easy way to collect a sterile urine sample. The minimally invasive catheter is pre-inserted into the specimen tube to ensure sterile technique.



### SPECI-CATH KITS – LATEX FREE

ITEM NO.	SIZE	CATHETER LENGTH	ALOETOUCH 3G GLOVES	3/PK PVP SWABSTICKS	LUBRICATING JELLY	PKG	HCPCS
DYND10815	8 Fr	9"	•	•	•	25/cs	A9270
DYND10820	5 Fr	9"	•	•	•	25/cs	A9270

## Vinyl Intermittent Catheters

Medline's pediatric vinyl intermittent catheters are 10" long and suitable for both male and female patients. Smooth tips and large eyes provide increased patient comfort.



### VINYL INTERMITTENT CATHETERS – LATEX FREE

ITEM NO.	DESCRIPTION	PKG	HCPCS
DYND10712	6 Fr, 10"	30/cs	A4351
DYND10713	8 Fr, 10"	30/cs	A4351
DYND10714	10 Fr, 10"	30/cs	A4351





## IN THIS SECTION

Irrigation Syringes . . . . .	62
Care and Maintenance . . . . .	63
Cysto/TUR Irrigation Sets . . . . .	64
Specimen Collection and Transport . . . . .	65
Midstream Kits . . . . .	68
Pathology Containers . . . . .	70

## Irrigation Syringes

Medline irrigation syringes have a unique barrier flange with “ears” to minimize hand slippage and subsequent contamination of barrel or solution container. Flat bottom solution container is sturdy and does not tip when filled with liquid. The 60 ml syringe barrel features large, raised, easy-to-read graduations in both ounces and milliliters. Rigid packaging includes graduated tray basin.

### Bulb Syringe

- Soft, pliable, textured polymer bulb for maximum control of drawn or expelled fluid
- Latex Free

### Piston Syringe

- Thumb ring helps minimize hand slippage and prevent contamination
- Latex Free



## IRRIGATION SYRINGES — BULB SYRINGES

ITEM NO.	DESC.	PACKAGE	PAD	SQ. JAR	DRAPE	LUER TIP	TIP PROTECTOR	PKG	HCPCS
DYND20100	Bulb	Rigid Base Wrapped in CSR	PVP	•	•		•	20/cs	A4320
DYND20102	Bulb	Rigid Base with Tyvek Lid	Alcohol	•	•		•	20/cs	A4320
DYND20125	Bulb	Soft with Tyvek Lid					•	50/cs	A4322
DYND20127*	Bulb	Bulk					•	50/cs	A4322

## IRRIGATION SYRINGES — PISTON SYRINGE

ITEM NO.	DESC.	PACKAGE	PAD	SQ. JAR	DRAPE	LUER TIP	TIP PROTECTOR	PKG	HCPCS
DYNC2303**	Piston	Rigid Base with Tyvek Lid	Alcohol	•	•		•	20/cs	A4320
DYND20300	Piston	Rigid Base Wrapped in CSR	PVP	•	•		•	20/cs	A4320
DYND20302	Piston	Rigid Base with Tyvek Lid	Alcohol	•	•		•	20/cs	A4320
DYND20325	Piston	Soft with Tyvek Lid				•	•	50/cs	A4322
DYND20327*	Piston	Bulk					•	50/cs	A4322

\* Non-sterile, \*\* 100 ml 0.9% NaCl

## Care and Maintenance

Our selection of urological care and maintenance products includes everything you need to meet the daily needs of your catheterized patients.

### Catheter Care Tray

Peel-lid, double-compartment tray includes:

- Wrapped pair of Aloetouch 3G Gloves
- PVP ointment
- PVP swabsticks 3/pk
- 4" x 4" gauze pad
- PVP prep pad
- Sterile packaged underpad



#### CARE AND MAINTENANCE CATHETER TRAY – LATEX FREE

ITEM NO.	DESCRIPTION	PKG	HCPCS
DYND12110	Catheter Care Tray	20/cs	A4310

### Luer Tip / Catheter Adapter

- Single Luer tip easily attaches to a syringe



#### LUER TIP / CATHETER ADAPTER

ITEM NO.	DESCRIPTION	PKG
DYND2219	Luer-Lock Tip Adapter	100/cs

## Cysto/TUR Irrigation Sets

Ideal for use in cystoscopy procedures or for continuous bladder irrigation, these latex-free sets are 90" in length and compatible for use with solution bags. Set includes:

- Roller clamp
- Drip chamber
- Spike for solution bags
- Packaged OR sterile

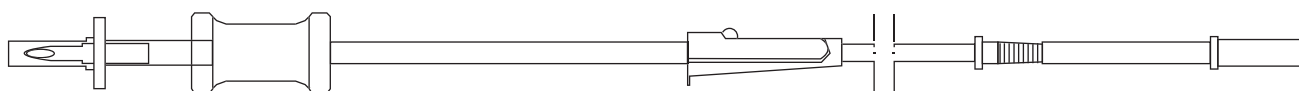

DYND19120

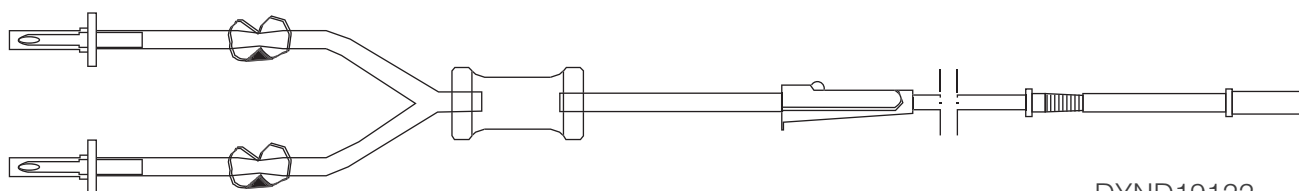

DYND19122

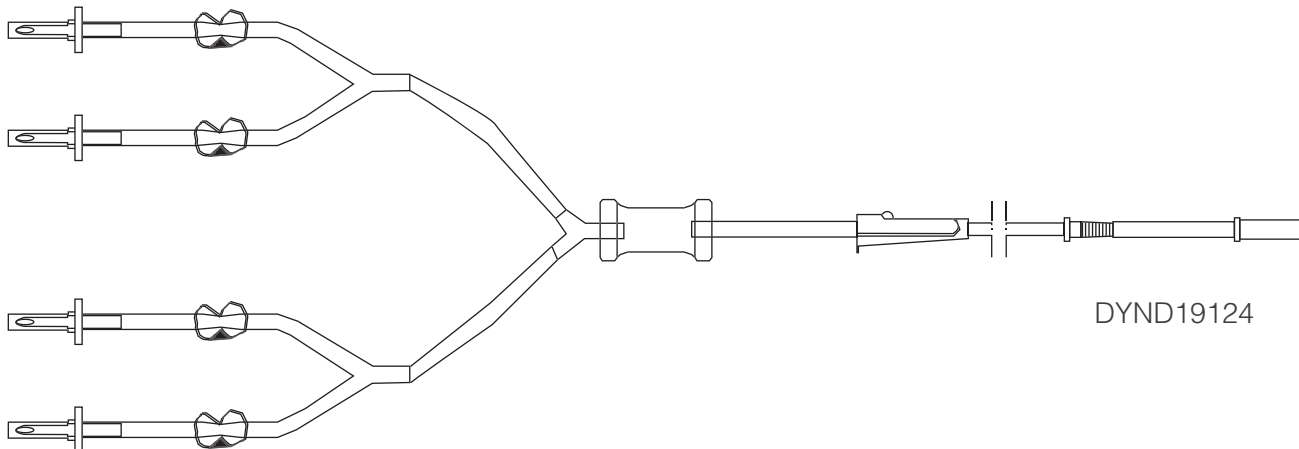

DYND19124

### CYSTO/TUR IRRIGATION SETS – LATEX FREE

ITEM NO.	DESCRIPTION	PKG	HCPCS
DYND19120	Cysto/TUR Irrigation Set with 0.188" I.D. Tubing	20/cs	A4355
DYND19122	"Y" Type Cysto/TUR Irrigation Set with .281" I.D. Tubing, 2 Roberts Clamps Above Drip Chamber	20/cs	A4355
DYND19124	4 Lead Irrigation Set with .281" I.D. Tubing, 4 Roberts Clamps Above Drip Chamber	20/cs	A4355

## Specimen Collection and Transport

To meet the needs of your patients and facility, Medline offers a wide selection of specimen collection and transport products.

### Pneumatic Tube System Specimen Containers

Polypropylene 95kPa specimen containers are available in both 3 oz. and 4 oz. volumes depending on clinician requirements.

- Continuous threaded screw-on lid for a tight seal
- Acceptable for use in pneumatic tubing systems while meeting DOT requirements
- Graduations in both ounces and milliliters
- Patient ID label

DYND30362



DYND30369



### PNEUMATIC TUBE SYSTEM SPECIMEN CONTAINERS

ITEM NO.	DESCRIPTION	PKG
DYND30362	3 oz./90 ml, Sterile Fluid Pathway with Tamper Evident-Seal	400/cs
DYND30367	3 oz./90 ml, Packaged Individually in Peel-Pouch, Sterile, Appropriate for OR Use	100/cs
DYND30364	4 oz./120 ml, sterile fluid pathway with Tamper Evident-Seal	300/cs
DYND30369	4 oz./120 ml, Packaged Individually in Peel-Pouch, Sterile, Appropriate for OR Use	100/cs



## Click-n-Close™ Pneumatic Tube Specimen Container, Polypropylene

Continuous threaded lid designed for a tight seal. A secure closure is accomplished with a natural motion, and an audible “click” ensures a tight fit.

- Graduations in both ounces and milliliters
- Patient ID label
- Pneumatic tube safe with 100kPa specifications
- Leak proof



DYND30382

### CLICK-N-CLOSE™ SPECIMEN CONTAINER

ITEM NO.	DESCRIPTION	PKG
DYND30382	3 oz. (90 ml), Sterile Fluid Pathway, Tamper-Evident Seal	400/cs
DYND30387	3 oz. (90 ml), Individually Packaged in Peel-Pouch, Sterile, Appropriate for OR use	100/cs
DYND30385	4 oz. (120 ml), Sterile Fluid Pathway, Tamper Evident-Seal	300/cs
DYND30389	4 oz. (120 ml), Individually Packaged in Peel-Pouch, Sterile, Appropriate for OR use	100/cs

## Click-n-Close™ Pneumatic Tube System Specimen Container, Polypropylene

The tamper-evident band breaks when seal is broken. A secure closure is accomplished with a natural motion, and an audible “click” ensures a tight and secure fit verified by a visual “bar” alignment.

- Graduations in both ounces and milliliters
- Patient ID label
- Leak-proof
- Capacity: 100 ml specimen
- Pneumatic tube safe with 95kPa specifications



DYND30370

### CLICK-N-CLOSE™ SPECIMEN CONTAINER

ITEM NO.	DESCRIPTION	PKG
DYND30370	100 ml, Sterile Fluid Pathway with Tamper-Evident Seal	400/cs

## General Use Specimen Container, Polypropylene

- General use specimen container with screw on lid
- Easy-to-read graduations in both ounces and milliliters



### SPECIMEN CONTAINER

ITEM NO.	DESCRIPTION	PKG
DYND30330	4 oz./120 ml, Packaged Individually in Poly-Bag, Sterile Fluid Pathway, Patient ID Label	100/cs
DYND30331	4 oz./120 ml, Packaged Individually in Peel-Pouch, Sterile, Appropriate for the OR	100/cs
DYND30335	4 oz./120 ml, Packaged Clean, Nested in Sleeve, 25 Containers and Lids Per Sleeve	500/cs
DYND30350	4.5 oz./130 ml, Packaged Individually in Poly-Bag, Sterile Fluid Pathway, Patient ID Label	100/cs
DYND30351	4.5 oz./130 ml, Packaged Individually in Peel-Pouch, Sterile, Appropriate for the OR	100/cs

## Deluxe Urinalysis Container

- Urinalysis container with pouring spout (6 oz./180 ml)
- Volume graduated in both ounces and milliliters
- Broad base helps minimize tipping

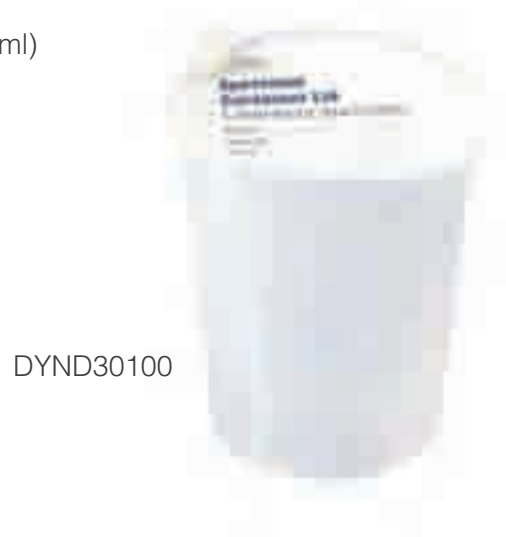

### DELUXE URINALYSIS CONTAINER

ITEM NO.	DESCRIPTION	PKG
DYND30100	Polystyrene Clear Plastic Container (No Lid)	500/cs
DYND30102	Polystyrene Clear Plastic Container with Pre-Printed Lids for Specimen Identification	500/cs
DYND30103	Polypropylene Container with Pre-Printed Lids for Specimen Identification	500/cs

## Mid-Stream Collection Kits

Protect specimens from contamination before during and after voiding.

### Basic Mid-Stream Collection Kits

Basic kit contains the following components:

- 4 oz./120 ml polypropylene specimen container
- Screw-on lid
- Instructions in both English and Spanish
- ID label
- Triple towelette packet



DYND30240

### BASIC MID-STREAM COLLECTION KITS, STERILE

ITEM NO.	DESCRIPTION	PKG	HCPCS
DYND30240	Kit with BZK Towelettes	100/cs	A9270

## Valu-Pak Mid-Stream Collection Kits

Medline kits include the following components:

- 4 oz./120 ml polypropylene specimen container
- Screw-on lid
- Attached protective collar
- Instructions in both English and Spanish
- ID label
- Triple towelette packet



### VALU-PAK MID-STREAM COLLECTION KITS, STERILE

ITEM NO.	DESCRIPTION	PKG	HCPCS
DYND30224	Kit with BZK Towelettes	100/cs	A9270
DYND30228	Kit With Castile Soap Towelettes	100/cs	A9270

## Deluxe Mid-Stream Collection Sets

Deluxe set contains the following components:

- 4 oz./120 ml polypropylene specimen container
- Anatomically correct funnel
- Screw-on lid
- Instructions in both English and Spanish
- ID label
- Zip closure specimen bag
- Triple towelette packet



### DELUXE MID-STREAM COLLECTION SETS, STERILE

ITEM NO.	DESCRIPTION	PKG	HCPCS
DYND30211	Kit with Castile Soap Towelettes	20/cs	A9270
DYND30212	Kit with 3 oz./90ml Pneumatic Tube Safe, Leak-Resistant Container and BZK Towelettes	40/cs	A9270

## Pathology Containers

- Made of a high-grade durable polypropylene
- Can be frozen without cracking

### Pathology Containers with Lids

- Secure, snap-lock caps minimize leaking



#### PATHOLOGY CONTAINERS WITH LIDS

ITEM NO.	DESCRIPTION	PKG
DYND34255	8 oz.	250/cs
DYND34260	16 oz.	100/cs
DYND34265	32 oz.	100/cs
DYND34270	64 oz.	50/cs
DYND34275	165 oz.	25/cs

## Speci-Catch Sputum/Specimen Collector

Ensures a sterile sample with less waste.

- 50 ml specimen tube with funnel top and cap eliminates the need for transferring
- Includes a 3-pk of BZK towelettes and specimen identification label

### SPECI-CATCH SPUTUM/SPECIMEN COLLECTOR

ITEM NO.	DESCRIPTION	PKG	HCPCS
DYND10850	Speci-Catch	30/cs	A9270

## Specimen Bags

Unique two-pouch design isolates patient specimen documents, reducing possibilities for contamination or accidental separation of specimen and paperwork.

- Specimen bags with zip closure and additional document pouch
- Includes Biohazard symbol



### BIOHAZARD SPECIMEN BAGS

ITEM NO.	DESCRIPTION	PKG
DYND30260	6" x 6" (15.2 cm x 15.2 cm) Bag with 6" x 6" (15.2 cm x 15.2 cm) Document Pouch	1,000/cs
DYND30261	6" x 9" (15.2 cm x 22.9 cm) Bag with 6" x 9" (15.2 cm x 22.9 cm) Document Pouch	1,000/cs
DYND30271	8" x 8" (20.3 cm x 20.3 cm) Bag with 8" x 8" (20.3 cm x 20.3 cm) Document Pouch	1,000/cs
DYND30281	12" x 15" (30.5 cm x 38.1 cm) Bag with 12" x 15" (30.5 cm x 38.1 cm) Document Pouch	500/cs



**2-LAYER FOLEY CATHETER TRAYS**

- 100% Silicone Foley Catheter Trays - Latex Free, 42
- Add-A-Cath Foley Catheter Trays - Latex Free, 39
- Lubricious Hydrophilic Latex Foley Catheter Trays, 40
- Silicone Elastomer-Coated Latex Foley Catheter Trays, 40
- Silvertouch 100% Silicone Foley Catheter Trays - Latex Free, 41

**ACCESSORIES, 25**

- Drain Bag Covers, 19, 24
- Drain Bag Holder, 25
- IV Pole with Drain Bag Hook, 25
- Care and Maintenance
  - Care and Maintenance Catheter Tray - Latex Free, 63
  - Luer Tip/Catheter Adapter, 63
- Cysto/TUR Irrigation Sets
  - Cysto/TUR Irrigation Sets - Latex Free, 64
- Irrigation Syringes
  - Bulb Syringes, 62
  - Piston Syringes, 62
- Mid-Stream Kits
  - Basic Mid-Stream Collection Kits, 68
  - Deluxe Mid-Stream Collection Kits, 69
  - Valu-Pak Mid-Stream Collection Kits, 69
- Pathology Containers
  - Biohazard Specimen Bags, 71
  - Pathology Containers with Lids, 70
  - Speci-Catch Sputum/Specimen Collector, 71
- Specimen Collection and Transport
  - Click-N-Close Specimen Container, 66
  - Deluxe Urinalysis Container, 67
  - General Use Specimen Container, 67
  - Pneumatic Tube System Specimen Containers, 65

**ALTERNATIVES TO FOLEY CATHETERS**

- Intermittent Catheterization Trays, 48
- Intermittent Catheters
  - Clear Vinyl Catheters - Latex Free, 46
  - Red Poly Catheters - Latex Free, 47
  - Red Rubber Intermittent Catheters - Coude Tip, 47
  - Red Rubber Intermittent Catheters - Male/Universal, 47
- Male Extrenal Catheters
  - 100% Silicone External Catheters - Latex Free, 50
  - Exo-Cath External Catheters, 50
- My-Cath Touch-Free Self-Catheter System, 49
- Speci-Cath Kits - Latex Free, 51

**BIOCON® 500 BLADDER SCANNER, 38**
**BUDDY THE BRAVE ERASE CAUTI TRAYS**

- Buddy the Brave 100% Silicone Pediatric Trays - Latex Free, 55
- Buddy the Brave 400-Series Temperature Sensing Pediatric Foley Catheter Trays - Latex Free, 56

**CARE AND MAINTENANCE**

- Care and Maintenance Catheter Tray - Latex Free, 63
- Luer Tip/Catheter Adapter, 63

**CATHETER SECUREMENT**

- Adhesive Patch, 27, 29
- Adhesive Securement Device, 27, 28
- Leg Straps, 27, 29

## ALPHABETICAL INDEX (continued)

### CLINICAL RESOURCES

Accredited Continuing Education  
Medline University (MU), 5

Comprehensive Programs

ERASE CAUTI, 5

ERASE CAUTI Program, 5, 28, 30, 31, 32, 33, 34, 35,  
36, 37, 38, 54, 55, 56

### CLOSED SYSTEM TRAYS

2-Layer Foley Catheter Trays

100% Silicone Foley Catheter Trays - Latex Free, 42

Add-A-Cath Trays - Latex Free, 39

Lubricious Hydrophilic Latex Foley Catheter Trays, 40

Silicone Elastomer-Coated Latex Foley Catheter  
Trays, 40

Silvertouch 100% Silicone Foley Catheter Trays -  
Latex Free, 41

ERASE CAUTI Foley Catheter Trays

100% Silicone Pediatric Foley Catheter Trays - Latex  
Free, 37

100% Silicone Foley Catheter Trays - Latex Free, 35, 36

Temperature Sensing Pediatric Foley Catheter Trays -  
Latex Free, 37

Temperature Sensing Foley Catheter Trays -  
Latex Free, 36

Add-A-Cath Trays - Latex Free, 34

Coude Silicone-Elastomer Coated Latex Foley  
Catheter Trays, 36

Silicone Elastomer-Coated Latex Trays, 35

ERASE CAUTI Program, 5, 28, 30, 31, 32, 33, 34, 35, 36,  
37, 38, 54, 55, 56

Foley Catheter Insertion Trays, 43

### CYSTO/TUR IRRIGATION SETS

Cysto/TUR Irrigation Sets - Latex Free, 64

### DRAIN BAGS

Accessories

Drain Bag Covers, 19, 24

Drain Bag Holder, 25

IV Pole with Drain Bag Hook, 25

Drain Bags

Belly Bag - Latex Free, 23

Drain Bags with Anti-Reflux Device, 22

Drain Bags with Anti-Reflux Tower, 21

Drain Bags with Anti-Reflux Valve, 22

Low Bed Drain Bag, 23, 24

Leg Bags

Leg Bag, 24

Exact Measure Pediatric Urine Meter - Latex Free, 58

Urine Meters, 19, 20

### ERASE CAUTI FOLEY CATHETER TRAYS

100% Silicone Pediatric Foley Catheter Trays -  
Latex Free, 37

100% Silicone Foley Catheter Trays - Latex Free, 35, 36

Temperature Sensing Pediatric Foley Catheter Trays -  
Latex Free, 37

Temperature Sensing Foley Catheter Trays -  
Latex Free, 36

Add-A-Cath Trays - Latex Free, 34

Coude Silicone-Elastomer Coated Latex  
Foley Catheter Trays, 36

Silicone Elastomer-Coated Latex Trays, 35

### FOLEY CATHETER INSERTION TRAYS, 43

## ALPHABETICAL INDEX (continued)

### FOLEY CATHETERS

- 100% Silicone Foley Catheters - Latex Free
  - 2-Way 100% Silicone Foley Catheters - Latex Free, 8
  - 2-Way Tiemann/Coude Tip 100% Silicone Foley Catheters - Latex Free, 9
  - 3-Way 100% Silicone Foley Catheters - Latex Free, 9
- Lubricious Hydrophilic Latex Foley Catheters
  - 2-Way Lubricious Hydrophilic Latex Foley Catheters, 14
- Silicone-Elastomer Coated Latex Foley Catheters
  - 2-Way Silicone-Elastomer Coated Latex Foley Catheters, 12
  - 2-Way Coude-Tip Silicone-Elastomer Coated Latex Foley Catheters, 13
  - 3-Way Silicone-Elastomer Coated Latex Foley Catheters, 13
- Silvertouch Foley Catheters
  - 2-Way Silvertouch Foley Catheters - Latex Free, 11
- Temperature-Sensing Foley Catheters - Latex Free
  - Temperature-Sensing Foley Catheters - Latex Free, 16
  - Temperature Sensing Cables - Latex Free, 17

### INTERMITTENT CATHETERIZATION TRAYS, 48

- Pre-Connected Intermittent Catheter Trays, 49

### INTERMITTENT CATHETERS

- Clear Vinyl Catheters - Latex Free, 46
- Red Poly Catheters - Latex Free, 47
- Red Rubber Intermittent Catheters - Coude Tip, 47
- Red Rubber Intermittent Catheters, 47

### IRRIGATION SYRINGES

- Bulb Syringes, 62
- Piston Syringes, 62

### LEG BAGS

- Leg Bags, 24

### LUBRICIOUS HYDROPHILIC LATEX FOLEY CATHETERS

- 2-Way Lubricious Hydrophilic Latex Foley Catheters, 14

### MALE EXTRENAL CATHETERS

- 100% Silicone External Catheters - Latex Free, 50
- Exo-Cath External Catheters, 50

### MID-STREAM KITS

- Basic Mid-Stream Collection Kits, 68
- Deluxe Mid-Stream Collection Kits, 69
- Valu-Pak Mid-Stream Collection Kits, 69

### MY-CATH TOUCH-FREE SELF-CATHETER SYSTEM, 49

### PATHOLOGY CONTAINERS

- Pathology Containers with Lids, 70

### PEDIATRICS

- Buddy the Brave ERASE CAUTI Trays
  - Buddy the Brave 100% Silicone Pediatric Trays - Latex Free, 55
  - Temperature-Sensing Foley Catheter Trays - Latex Free, 56
- Exact Measure Pediatric Urine Meter
  - Exact Measure Pediatric Urine Meter - Latex Free, 58
  - Infant Urine Collectors - Latex Free, 58
- Pediatric Foley Catheters
  - 100% Silicone Foley Catheters - Latex Free, 57
  - Silicone Elastomer Coated Latex Foley Catheters, 57
  - Temperature-Sensing Foley Catheter - Latex Free, 56
- Speci-Cath Kits
  - Speci-Cath Kits - Latex Free, 59

## ALPHABETICAL INDEX (continued)

### Urine Meter Collection

- Exact Measure Pediatric Urine Meter - Latex Free, 58
- Infant Urine Collectors - Latex Free, 58

### Vinyl Intermittent Catheters

- Vinyl Intermittent Catheters - Latex Free, 59

### PRE-CONNECTED INTERMITTENT CATHETER TRAYS, 49

### RED RUBBER INTERMITTENT CATHETERS, 47

### SILICONE-ELASTOMER COATED LATEX FOLEY CATHETERS

- 2-Way Silicone-Elastomer Coated Latex Foley Catheters, 12
- 2-Way Coude-Tip Silicone-Elastomer Coated Latex Foley Catheters, 13
- 3-Way Silicone-Elastomer Coated Latex Foley Catheters, 13

### SILICONE FOLEY CATHETERS, 100%

- 2-Way 100% Silicone Foley Catheters - Latex Free, 8
- 2-Way Tiemann/Coude Tip 100% Silicone Foley Catheters - Latex Free, 9
- 3-Way 100% Silicone Foley Catheters - Latex Free, 9

### SILVERTOUCH FOLEY CATHETERS

- 2-Way Silvertouch Foley Catheters - Latex Free, 11

### SPECI-CATH KITS, 51

### SPECIMEN COLLECTION AND TRANSPORT

- Click-N-Close Specimen Container, 66
- Deluxe Urinalysis Container, 67
- General Use Specimen Container, 67
- Pneumatic Tube System Specimen Containers, 65
- Biohazard Specimen Bags, 71

### TEMPERATURE-SENSING FOLEY CATHETERS

- Temperature-Sensing Foley Catheters - Latex Free, 16
- Temperature Sensing Cables - Latex Free, 17

### URINE METERS 19, 20

### VINYL INTERMITTENT CATHETERS

- Vinyl Intermittent Catheters - Latex Free, 59



# ITEM NUMBER INDEX

ITEM NUMBER	PAGE	ITEM NUMBER	PAGE	ITEM NUMBER	PAGE
DYNC1674 22		DYND10703	46	DYND11503	8
DYNC1810 43		DYND10712	46, 59	DYND11504	8
DYNC1814 43		DYND10713	46, 59	DYND11505	8
DYNC1815 43		DYND10714	46, 59	DYND11506	8
DYNC1816 48		DYND10721	46	DYND11523	42
DYNC1820 48		DYND10722	46	DYND11528	42
DYNC2303	62	DYND10723	46	DYND11532	8
DYND1516SEC	40	DYND10724	46	DYND11533	8
DYND1516SIL	42	DYND10725	46	DYND11534	8
DYND1518SEC	40	DYND10800	51	DYND11535	8
DYND1518SIL	42	DYND10805	51	DYND11536	8
DYND2219	63	DYND10806	51	DYND11552	8, 57
DYND7600FCL	28	DYND10810	51	DYND11553	8, 57
DYND10150	43	DYND10815	59	DYND11554	8, 57
DYND10160	43	DYND10820	59	DYND11572	9
DYND10200	43	DYND10850	71	DYND11573	9
DYND10300	48	DYND11003	40	DYND11574	9
DYND10305	48	DYND11008	40	DYND11575	9
DYND10350	48	DYND11090	39	DYND11576	9
DYND10400	49	DYND11095	39	DYND11706	12, 57
DYND10402	49	DYND11214 13		DYND11708	12, 57
DYND10407	49	DYND11216 13		DYND11710	12, 57
DYND10440	49	DYND11218	13	DYND11752	12
DYND10500	48	DYND11220	13	DYND11754	12
DYND10700	46	DYND11500	8	DYND11756	12
DYND10701	46	DYND11501	8	DYND11758	12
DYND10702	46	DYND11502	8	DYND11760	12

ITEM NUMBER INDEX (continued)

ITEM NUMBER	PAGE	ITEM NUMBER	PAGE	ITEM NUMBER	PAGE
DYND11762	12	DYND11920	14	DYND13508	47
DYND11764	12	DYND11922	14	DYND13510	47
DYND11766	12	DYND11924	14	DYND13512	47
DYND11768	12	DYND11926	14	DYND13514	47
DYND11770	12	DYND11928	14	DYND13515	47
DYND11772	12	DYND11930	14	DYND13516	47
DYND11774	12	DYND11932	14	DYND13518	47
DYND11776	12	DYND11934	14	DYND13520	47
DYND11778	12	DYND11936	14	DYND13522	47
DYND11780	12	DYND11938	14	DYND13714	47
DYND11782	12	DYND11940	14	DYND15200	24
DYND11784	12	DYND11942	14	DYND15200LOW	24
DYND11786	12	DYND11944	14	DYND15203	21
DYND11788	12	DYND11946	14	DYND15205	21
DYND11790	12	DYND11948	14	DYND15207	22
DYND11800	13	DYND11950	14	DYND15210	22
DYND11801	13	DYND12110	63	DYND15215	23
DYND11802	13	DYND12200	25	DYND15405	21
DYND11803	13	DYND12301	50	DYND16700	29
DYND11804	13	DYND12302	50	DYND16800	29
DYND11805	13	DYND12303	50	DYND16900	29
DYND11903	40	DYND12550	25	DYND16905	29
DYND11908	40	DYND12574	24	DYND17403	20
DYND11912	14	DYND12575	24	DYND17407	20, 58
DYND11914	14	DYND12578	24	DYND18100	43
DYND11916	14	DYND12584	24	DYND19120	64
DYND11918	14	DYND12588	24	DYND19122	64



ITEM NUMBER INDEX (continued)

ITEM NUMBER	PAGE	ITEM NUMBER	PAGE	ITEM NUMBER	PAGE
DYND19124	64	DYND30364	65	DYND141010	11
DYND20100	62	DYND30367	65	DYND141012	11
DYND20102	62	DYND30369	65	DYND141014	11
DYND20125	62	DYND30370	66	DYND141016	11
DYND20127	62	DYND30382	66	DYND141018	11
DYND20300	62	DYND30385	66	DYND141020	11
DYND20302	62	DYND30387	66	DYND141022	11
DYND20325	62	DYND30389	66	DYND141024	11
DYND20327	62	DYND34255	70	DYND141216	11
DYND30100	67	DYND34260	70	DYND141218	11
DYND30102	67	DYND34265	70	DYND141220	11
DYND30103	67	DYND34270	70	DYND160100	34
DYND30211	69	DYND34275	70	DYND160114	35
DYND30212	69	DYND110101	17	DYND160116	35
DYND30224	69	DYND110102	17	DYND160116C	36
DYND30228	69	DYND110103	17	DYND160118	35
DYND30240	68	DYND110508	16, 56	DYND160200	34
DYND30260	71	DYND110510	16, 56	DYND160214	35
DYND30261	71	DYND110512	16	DYND160216	35
DYND30271	71	DYND110514	16	DYND160218	35
DYND30281	71	DYND110516	16	DYND160414	35
DYND30330	67	DYND110518	16	DYND160416	35
DYND30331	67	DYND140214	41	DYND160418	35
DYND30335	67	DYND140216	41	DYND160514	35
DYND30350	67	DYND140218	41	DYND160516	35
DYND30351	67	DYND140416	41	DYND160518	35
DYND30362	65	DYND140418	41	DYND160714	36

ITEM NUMBER INDEX (continued)

ITEM NUMBER	PAGE	ITEM NUMBER	PAGE
DYND160716	36	MDS092005	38
DYND160718	36	MDS190505	58
DYND160806	37, 55	MDS190510	58
DYND160808	37, 55	MDS3110100032	38
DYND160808T	37, 56	MDSB10500	38
DYND160810	37, 55	MDT825150	25
DYND160810T	37, 56	RCH33301	50
DYND160814	36	RCH33302	50
DYND160814T	36	RCH33303	50
DYND160816	36	RCH33304	50
DYND160816T	36	RCH33305	50
DYND160818	36	RCH36301	50
DYND160818T	36	RCH36302	50
LFTB1000	23	RCH36303	50
LFTB1000P	23	RCH36304	50
MDS80600	25	RCH36305	50
MDS80600UBH	25		